





Chicago Faucets Laboratory Products

## Unparalleled Quality

Since 1901, Chicago Faucets has been the leading brand of commercial faucets and fixtures in the United States. Every one of our products is manufactured to the same high standard that has made us the choice of professionals in education, healthcare, research, public assembly, food service, hospitality, and commercial buildings all across the country.

Now, you can get the same unparalleled quality and support with our extensive offering of laboratory products. Like our commercial faucets, the components of our laboratory products are interchangeable. So, you can easily design a product to meet your unique needs. You also get a single source for all of your faucet needs – from the lab to the restroom, janitorial closet, cafeteria and more.

## Table of Contents

SECTION	TAB	PAGE
<b>Laboratory Water</b>	Laboratory Water Valves	4-15
	Laboratory Water Single Faucets	16-35
	Laboratory Water Mixing Faucets	36-49
	Laboratory General Faucets	50-53
	Foot Operated Pedal Valves	54-55
	Laboratory Electronic Faucets	56-57
	Laboratory Pre-Rinse Fittings	58-59
<b>Laboratory Gas</b>	Laboratory Gas Needle Valves	60-71
	Laboratory Gas Fine Needle Valves	72-83
	Laboratory Gas Ball Valves	84-89
<b>Laboratory Pure Water</b>	Laboratory Pure Water Faucets	90-91
<b>Laboratory Steam</b>	Laboratory Steam Valves	92-97
<b>Combination Fittings</b>	Laboratory Combination Fittings	98-107
<b>Fume Hoods</b>	Laboratory Remote Spouts	108-113
	Laboratory Remote Valves	114-123
<b>Electrical Outlet Boxes</b>	Boxes, Rods, Sockets, Clamps	124-125
<b>Safety Products</b>	Laboratory Safety Products	126-127

## How to build and order a Chicago Faucets laboratory water valve fitting.

Chicago Faucets makes it easy for you to build water valve fittings that meet your exact requirements. You can reference the charts on the following pages, or you can build your own valve by choosing the components below to configure your model number.



### Valve Base

**A**

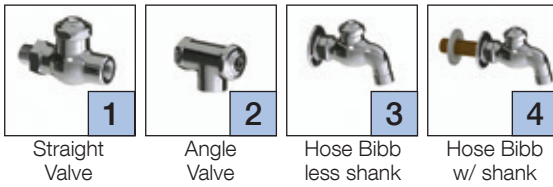

### Cartridge

**B**

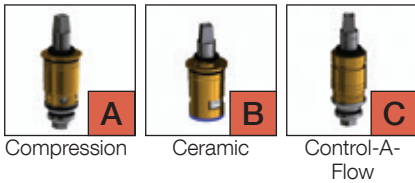

**EXAMPLE**

**LWV1-A12-20**  
 Two straight valves with compression cartridges, straight nozzles, metal handles with hot index buttons, and a dual 90° turret.

### Outlet

**C**

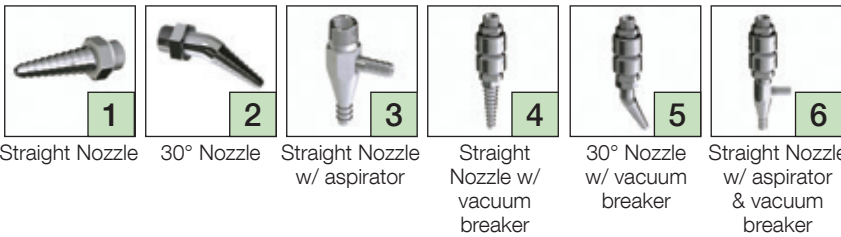

### Handle

**D**

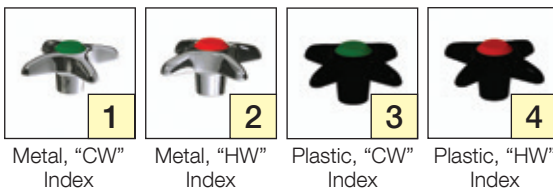

### Turret

**E**



## Straight Pattern Water Valve

- Solid brass straight valve body
- Polished chrome plated finish
- 2-1/2" vandal proof cross handle
- 3/8" - 18 NPT male thread inlet



### Straight Nozzle

Handle/Index	Vacuum Breaker	Compression Cartridge	Ceramic Cartridge	Control-A-Flow Cartridge
Metal/Cold	-	<b>LWV1-A11</b>	LWV1-B11	LWV1-C11
	•	LWV1-A41	LWV1-B41	LWV1-C41
Metal/Hot	-	LWV1-A12	LWV1-B12	LWV1-C12
	•	LWV1-A42	LWV1-B42	LWV1-C42
Plastic/Cold	-	LWV1-A13	LWV1-B13	LWV1-C13
	•	LWV1-A43	LWV1-B43	LWV1-C43
Plastic/Hot	-	LWV1-A14	LWV1-B14	LWV1-C14
	•	LWV1-A44	LWV1-B44	LWV1-C44

### 30° Nozzle

Handle/Index	Vacuum Breaker	Compression Cartridge	Ceramic Cartridge	Control-A-Flow Cartridge
Metal/Cold	-	LWV1-A21	LWV1-B21	LWV1-C21
	•	LWV1-A51	LWV1-B51	LWV1-C51
Metal/Hot	-	LWV1-A22	LWV1-B22	LWV1-C22
	•	LWV1-A52	LWV1-B52	LWV1-C52
Plastic/Cold	-	LWV1-A23	LWV1-B23	LWV1-C23
	•	LWV1-A53	LWV1-B53	LWV1-C53
Plastic/Hot	-	<b>LWV1-A24</b>	LWV1-B24	LWV1-C24
	•	LWV1-A54	LWV1-B54	LWV1-C54

### Straight Nozzle With Aspirator

Handle/Index	Vacuum Breaker	Compression Cartridge	Ceramic Cartridge	Control-A-Flow Cartridge
Metal/Cold	-	LWV1-A31	LWV1-B31	LWV1-C31
	•	LWV1-A61	LWV1-B61	LWV1-C61
Metal/Hot	-	LWV1-A32	LWV1-B32	LWV1-C32
	•	LWV1-A62	LWV1-B62	LWV1-C62
Plastic/Cold	-	LWV1-A33	LWV1-B33	LWV1-C33
	•	LWV1-A63	LWV1-B63	LWV1-C63
Plastic/Hot	-	LWV1-A34	LWV1-B34	LWV1-C34
	•	LWV1-A64	LWV1-B64	LWV1-C64

## Deck Mounted, Straight Pattern Single Water Valve Assembly

- Solid brass turret with one outlet
- Solid brass straight valve body
- Polished chrome plated finish
- 2-1/2" vandal proof cross handle
- 3/8" - 18 NPT male thread shank assembly



### Straight Nozzle

Handle/Index	Vacuum Breaker	Compression Cartridge	Ceramic Cartridge	Control-A-Flow Cartridge
Metal/Cold	-	LWV1-A11-10	LWV1-B11-10	LWV1-C11-10
	•	LWV1-A41-10	LWV1-B41-10	LWV1-C41-10
Metal/Hot	-	<b>LWV1-A12-10</b>	LWV1-B12-10	LWV1-C12-10
	•	LWV1-A42-10	LWV1-B42-10	LWV1-C42-10
Plastic/Cold	-	LWV1-A13-10	LWV1-B13-10	LWV1-C13-10
	•	LWV1-A43-10	LWV1-B43-10	LWV1-C43-10
Plastic/Hot	-	LWV1-A14-10	LWV1-B14-10	LWV1-C14-10
	•	LWV1-A44-10	LWV1-B44-10	LWV1-C44-10

### 30° Nozzle

Handle/Index	Vacuum Breaker	Compression Cartridge	Ceramic Cartridge	Control-A-Flow Cartridge
Metal/Cold	-	LWV1-A21-10	LWV1-B21-10	LWV1-C21-10
	•	LWV1-A51-10	LWV1-B51-10	LWV1-C51-10
Metal/Hot	-	LWV1-A22-10	LWV1-B22-10	LWV1-C22-10
	•	LWV1-A52-10	LWV1-B52-10	LWV1-C52-10
Plastic/Cold	-	LWV1-A23-10	LWV1-B23-10	LWV1-C23-10
	•	LWV1-A53-10	LWV1-B53-10	LWV1-C53-10
Plastic/Hot	-	LWV1-A24-10	LWV1-B24-10	LWV1-C24-10
	•	LWV1-A54-10	LWV1-B54-10	LWV1-C54-10

### Straight Nozzle With Aspirator

Handle/Index	Vacuum Breaker	Compression Cartridge	Ceramic Cartridge	Control-A-Flow Cartridge
Metal/Cold	-	LWV1-A31-10	LWV1-B31-10	LWV1-C31-10
	•	LWV1-A61-10	LWV1-B61-10	LWV1-C61-10
Metal/Hot	-	LWV1-A32-10	LWV1-B32-10	LWV1-C32-10
	•	LWV1-A62-10	LWV1-B62-10	LWV1-C62-10
Plastic/Cold	-	LWV1-A33-10	LWV1-B33-10	LWV1-C33-10
	•	LWV1-A63-10	LWV1-B63-10	LWV1-C63-10
Plastic/Hot	-	LWV1-A34-10	LWV1-B34-10	LWV1-C34-10
	•	LWV1-A64-10	LWV1-B64-10	LWV1-C64-10

## Deck Mounted, Straight Pattern Dual 90° Water Valve Assembly

- Solid brass turret with two 90° outlets
- Solid brass straight valve body
- Polished chrome plated finish
- 2-1/2" vandal proof cross handle
- 3/8" - 18 NPT male thread shank assembly



Straight Nozzle

Handle/Index	Vacuum Breaker	Compression Cartridge	Ceramic Cartridge	Control-A-Flow Cartridge
Metal/Cold	–	LWW1-A11-20	LWW1-B11-20	LWW1-C11-20
	•	LWW1-A41-20	LWW1-B41-20	LWW1-C41-20
Metal/Hot	–	<b>LWW1-A12-20</b>	LWW1-B12-20	LWW1-C12-20
	•	LWW1-A42-20	LWW1-B42-20	LWW1-C42-20
Plastic/Cold	–	LWW1-A13-20	LWW1-B13-20	LWW1-C13-20
	•	LWW1-A43-20	LWW1-B43-20	LWW1-C43-20
Plastic/Hot	–	LWW1-A14-20	LWW1-B14-20	LWW1-C14-20
	•	LWW1-A44-20	LWW1-B44-20	LWW1-C44-20

30° Nozzle

Handle/Index	Vacuum Breaker	Compression Cartridge	Ceramic Cartridge	Control-A-Flow Cartridge
Metal/Cold	–	LWW1-A21-20	LWW1-B21-20	LWW1-C21-20
	•	LWW1-A51-20	LWW1-B51-20	LWW1-C51-20
Metal/Hot	–	LWW1-A22-20	LWW1-B22-20	LWW1-C42-20
	•	LWW1-A52-20	LWW1-B52-20	LWW1-C52-20
Plastic/Cold	–	LWW1-A23-20	LWW1-B23-20	LWW1-C23-20
	•	LWW1-A53-20	LWW1-B53-20	LWW1-C53-20
Plastic/Hot	–	LWW1-A24-20	LWW1-B24-20	LWW1-C24-20
	•	LWW1-A54-20	LWW1-B54-20	LWW1-C54-20

Straight Nozzle With Aspirator

Handle/Index	Vacuum Breaker	Compression Cartridge	Ceramic Cartridge	Control-A-Flow Cartridge
Metal/Cold	–	LWW1-A31-20	LWW1-B31-20	LWW1-C31-20
	•	LWW1-A61-20	LWW1-B61-20	LWW1-C61-20
Metal/Hot	–	LWW1-A32-20	LWW1-B32-20	LWW1-C32-20
	•	LWW1-A62-20	LWW1-B62-20	LWW1-C62-20
Plastic/Cold	–	LWW1-A33-20	LWW1-B33-20	LWW1-C33-20
	•	LWW1-A63-20	LWW1-B63-20	LWW1-C63-20
Plastic/Hot	–	LWW1-A34-20	LWW1-B34-20	LWW1-C34-20
	•	LWW1-A64-20	LWW1-B64-20	LWW1-C64-20

## Deck Mounted, Straight Pattern Dual 180° Water Valve Assembly

- Solid brass turret with two 180° outlets
- Solid brass straight valve body
- Polished chrome plated finish
- 2-1/2" vandal proof cross handle
- 3/8" - 18 NPT male thread shank assembly



Straight Nozzle

Handle/Index	Vacuum Breaker	Compression Cartridge	Ceramic Cartridge	Control-A-Flow Cartridge
Metal/Cold	–	<b>LWW1-A11-25</b>	LWW1-B11-25	LWW1-C11-25
	•	LWW1-A41-25	LWW1-B41-25	LWW1-C41-25
Metal/Hot	–	LWW1-A12-25	LWW1-B12-25	LWW1-C12-25
	•	LWW1-A42-25	LWW1-B42-25	LWW1-C42-25
Plastic/Cold	–	LWW1-A13-25	LWW1-B13-25	LWW1-C13-25
	•	LWW1-A43-25	LWW1-B43-25	LWW1-C43-25
Plastic/Hot	–	LWW1-A14-25	LWW1-B14-25	LWW1-C14-25
	•	LWW1-A44-25	LWW1-B44-25	LWW1-C44-25

30° Nozzle

Handle/Index	Vacuum Breaker	Compression Cartridge	Ceramic Cartridge	Control-A-Flow Cartridge
Metal/Cold	–	LWW1-A21-25	LWW1-B21-25	LWW1-C21-25
	•	LWW1-A51-25	LWW1-B51-25	LWW1-C51-25
Metal/Hot	–	LWW1-A22-25	LWW1-B22-25	LWW1-C22-25
	•	LWW1-A52-25	LWW1-B52-25	LWW1-C52-25
Plastic/Cold	–	LWW1-A23-25	LWW1-B23-25	LWW1-C23-25
	•	LWW1-A53-25	LWW1-B53-25	LWW1-C53-25
Plastic/Hot	–	LWW1-A24-25	LWW1-B24-25	LWW1-C24-25
	•	LWW1-A54-25	LWW1-B54-25	LWW1-C54-25

Straight Nozzle With Aspirator

Handle/Index	Vacuum Breaker	Compression Cartridge	Ceramic Cartridge	Control-A-Flow Cartridge
Metal/Cold	–	LWW1-A31-25	LWW1-B31-25	LWW1-C31-25
	•	LWW1-A61-25	LWW1-B61-25	LWW1-C61-25
Metal/Hot	–	LWW1-A32-25	LWW1-B32-25	LWW1-C32-25
	•	LWW1-A62-25	LWW1-B62-25	LWW1-C62-25
Plastic/Cold	–	LWW1-A33-25	LWW1-B33-25	LWW1-C33-25
	•	LWW1-A63-25	LWW1-B63-25	LWW1-C63-25
Plastic/Hot	–	LWW1-A34-25	LWW1-B34-25	LWW1-C34-25
	•	LWW1-A64-25	LWW1-B64-25	LWW1-C64-25

## Deck Mounted, Straight Pattern Three Water Valve Assembly

- Solid brass turret with three outlets
- Solid brass straight valve body
- Polished chrome plated finish
- 2-1/2" vandal proof cross handle
- 3/8" - 18 NPT male thread shank assembly



Straight Nozzle

Handle/Index	Vacuum Breaker	Compression Cartridge	Ceramic Cartridge	Control-A-Flow Cartridge
Metal/Cold	–	<b>LWV1-A11-30</b>	LWV1-B11-30	LWV1-C11-30
	•	LWV1-A41-30	LWV1-B41-30	LWV1-C41-30
Metal/Hot	–	LWV1-A12-30	LWV1-B12-30	LWV1-C12-30
	•	LWV1-A42-30	LWV1-B42-30	LWV1-C42-30
Plastic/Cold	–	LWV1-A13-30	LWV1-B13-30	LWV1-C13-30
	•	LWV1-A43-30	LWV1-B43-30	LWV1-C43-30
Plastic/Hot	–	LWV1-A14-30	LWV1-B14-30	LWV1-C14-30
	•	LWV1-A44-30	LWV1-B44-30	LWV1-C44-30

30° Nozzle

Handle/Index	Vacuum Breaker	Compression Cartridge	Ceramic Cartridge	Control-A-Flow Cartridge
Metal/Cold	–	LWV1-A21-30	LWV1-B21-30	LWV1-C21-30
	•	LWV1-A51-30	LWV1-B51-30	LWV1-C51-30
Metal/Hot	–	LWV1-A22-30	LWV1-B22-30	LWV1-C22-30
	•	LWV1-A52-30	LWV1-B52-30	LWV1-C52-30
Plastic/Cold	–	LWV1-A23-30	LWV1-B23-30	LWV1-C23-30
	•	LWV1-A53-30	LWV1-B53-30	LWV1-C53-30
Plastic/Hot	–	LWV1-A24-30	LWV1-B24-30	LWV1-C24-30
	•	LWV1-A54-30	LWV1-B54-30	LWV1-C54-30

Straight Nozzle With Aspirator

Handle/Index	Vacuum Breaker	Compression Cartridge	Ceramic Cartridge	Control-A-Flow Cartridge
Metal/Cold	–	LWV1-A31-30	LWV1-B31-30	LWV1-C31-30
	•	LWV1-A61-30	LWV1-B61-30	LWV1-C61-30
Metal/Hot	–	LWV1-A32-30	LWV1-B32-30	LWV1-C32-30
	•	LWV1-A62-30	LWV1-B62-30	LWV1-C62-30
Plastic/Cold	–	LWV1-A33-30	LWV1-B33-30	LWV1-C33-30
	•	LWV1-A63-30	LWV1-B63-30	LWV1-C63-30
Plastic/Hot	–	LWV1-A34-30	LWV1-B34-30	LWV1-C34-30
	•	LWV1-A64-30	LWV1-B64-30	LWV1-C64-30

## Deck Mounted, Straight Pattern Four Water Valve Assembly

- Solid brass turret with four outlets
- Solid brass straight valve body
- Polished chrome plated finish
- 2-1/2" vandal proof cross handle
- 3/8" - 18 NPT male thread shank assembly



Straight Nozzle

Handle/Index	Vacuum Breaker	Compression Cartridge	Ceramic Cartridge	Control-A-Flow Cartridge
Metal/Cold	–	<b>LWV1-A11-40</b>	LWV1-B11-40	LWV1-C11-40
	•	LWV1-A41-40	LWV1-B41-40	LWV1-C41-40
Metal/Hot	–	LWV1-A12-40	LWV1-B12-40	LWV1-C12-40
	•	LWV1-A42-40	LWV1-B42-40	LWV1-C42-40
Plastic/Cold	–	LWV1-A13-40	LWV1-B13-40	LWV1-C13-40
	•	LWV1-A43-40	LWV1-B43-40	LWV1-C43-40
Plastic/Hot	–	LWV1-A14-40	LWV1-B14-40	LWV1-C14-40
	•	LWV1-A44-40	LWV1-B44-40	LWV1-C44-40

30° Nozzle

Handle/Index	Vacuum Breaker	Compression Cartridge	Ceramic Cartridge	Control-A-Flow Cartridge
Metal/Cold	–	LWV1-A21-40	LWV1-B21-40	LWV1-C21-40
	•	LWV1-A51-40	LWV1-B51-40	LWV1-C51-40
Metal/Hot	–	LWV1-A22-40	LWV1-B22-40	LWV1-C22-40
	•	LWV1-A52-40	LWV1-B52-40	LWV1-C52-40
Plastic/Cold	–	LWV1-A23-40	LWV1-B23-40	LWV1-C23-40
	•	LWV1-A53-40	LWV1-B53-40	LWV1-C53-40
Plastic/Hot	–	LWV1-A24-40	LWV1-B24-40	LWV1-C24-40
	•	LWV1-A54-40	LWV1-B54-40	LWV1-C54-40

Straight Nozzle With Aspirator

Handle/Index	Vacuum Breaker	Compression Cartridge	Ceramic Cartridge	Control-A-Flow Cartridge
Metal/Cold	–	LWV1-A31-40	LWV1-B31-40	LWV1-C31-40
	•	LWV1-A61-40	LWV1-B61-40	LWV1-C61-40
Metal/Hot	–	LWV1-A32-40	LWV1-B32-40	LWV1-C32-40
	•	LWV1-A62-40	LWV1-B62-40	LWV1-C62-40
Plastic/Cold	–	LWV1-A33-40	LWV1-B33-40	LWV1-C33-40
	•	LWV1-A63-40	LWV1-B63-40	LWV1-C63-40
Plastic/Hot	–	LWV1-A34-40	LWV1-B34-40	LWV1-C34-40
	•	LWV1-A64-40	LWV1-B64-40	LWV1-C64-40

## Wall Mounted, Straight Pattern Single Water Valve Assembly Less Shank

- Solid brass straight valve body
- Wall flange
- Polished chrome plated finish
- 2-1/2" vandal proof cross handle
- 3/8" - 18 NPT female thread inlet



### Straight Nozzle

Handle/Index	Vacuum Breaker	Compression Cartridge	Ceramic Cartridge	Control-A-Flow Cartridge
Metal/Cold	-	LWW1-A11-50	LWW1-B11-50	LWW1-C11-50
	•	<b>LWW1-A41-50</b>	LWW1-B41-50	LWW1-C41-50
Metal/Hot	-	LWW1-A12-50	LWW1-B12-50	LWW1-C12-50
	•	LWW1-A42-50	LWW1-B42-50	LWW1-C42-50
Plastic/Cold	-	LWW1-A13-50	LWW1-B13-50	LWW1-C13-50
	•	LWW1-A43-50	LWW1-B43-50	LWW1-C43-50
Plastic/Hot	-	LWW1-A14-50	LWW1-B14-50	LWW1-C14-50
	•	LWW1-A44-50	LWW1-B44-50	LWW1-C44-50

### 30° Nozzle

Handle/Index	Vacuum Breaker	Compression Cartridge	Ceramic Cartridge	Control-A-Flow Cartridge
Metal/Cold	-	LWW1-A21-50	LWW1-B21-50	LWW1-C21-50
	•	LWW1-A51-50	LWW1-B51-50	LWW1-C51-50
Metal/Hot	-	LWW1-A22-50	LWW1-B22-50	LWW1-C22-50
	•	LWW1-A52-50	LWW1-B52-50	LWW1-C52-50
Plastic/Cold	-	LWW1-A23-50	LWW1-B23-50	LWW1-C23-50
	•	LWW1-A53-50	LWW1-B53-50	LWW1-C53-50
Plastic/Hot	-	LWW1-A24-50	LWW1-B24-50	LWW1-C24-50
	•	LWW1-A54-50	LWW1-B54-50	LWW1-C54-50

### Straight Nozzle With Aspirator

Handle/Index	Vacuum Breaker	Compression Cartridge	Ceramic Cartridge	Control-A-Flow Cartridge
Metal/Cold	-	LWW1-A31-50	LWW1-B31-50	LWW1-C31-50
	•	LWW1-A61-50	LWW1-B61-50	LWW1-C61-50
Metal/Hot	-	LWW1-A32-50	LWW1-B32-50	LWW1-C32-50
	•	LWW1-A62-50	LWW1-B62-50	LWW1-C62-50
Plastic/Cold	-	LWW1-A33-50	LWW1-B33-50	LWW1-C33-50
	•	LWW1-A63-50	LWW1-B63-50	LWW1-C63-50
Plastic/Hot	-	LWW1-A34-50	LWW1-B34-50	LWW1-C34-50
	•	LWW1-A64-50	LWW1-B64-50	LWW1-C64-50

## Wall Mounted, Straight Pattern Single Water Valve Assembly With Shank

- Solid brass straight valve body
- Wall flange
- Forged brass straight valve body
- Polished chrome plated finish
- 2-1/2" vandal proof cross handle
- 3/8" - 18 NPT male thread shank assembly



### Straight Nozzle

Handle/Index	Vacuum Breaker	Compression Cartridge	Ceramic Cartridge	Control-A-Flow Cartridge
Metal/Cold	-	LWW1-A11-55	LWW1-B11-55	LWW1-C11-55
	•	LWW1-A41-55	LWW1-B41-55	LWW1-C41-55
Metal/Hot	-	LWW1-A12-55	LWW1-B12-55	LWW1-C12-55
	•	LWW1-A42-55	LWW1-B42-55	LWW1-C42-55
Plastic/Cold	-	LWW1-A13-55	LWW1-B13-55	LWW1-C13-55
	•	LWW1-A43-55	LWW1-B43-55	LWW1-C43-55
Plastic/Hot	-	LWW1-A14-55	LWW1-B14-55	LWW1-C14-55
	•	LWW1-A44-55	LWW1-B44-55	LWW1-C44-55

### Straight Nozzle With Aspirator

Handle/Index	Vacuum Breaker	Compression Cartridge	Ceramic Cartridge	Control-A-Flow Cartridge
Metal/Cold	-	LWW1-A31-55	LWW1-B31-55	LWW1-C31-55
	•	LWW1-A61-55	LWW1-B61-55	LWW1-C61-55
Metal/Hot	-	LWW1-A32-55	LWW1-B32-55	LWW1-C32-55
	•	LWW1-A62-55	LWW1-B62-55	LWW1-C62-55
Plastic/Cold	-	LWW1-A33-55	LWW1-B33-55	LWW1-C33-55
	•	LWW1-A63-55	LWW1-B63-55	LWW1-C63-55
Plastic/Hot	-	LWW1-A34-55	LWW1-B34-55	LWW1-C34-55
	•	LWW1-A64-55	LWW1-B64-55	LWW1-C64-55

### 30° Nozzle

Handle/Index	Vacuum Breaker	Compression Cartridge	Ceramic Cartridge	Control-A-Flow Cartridge
Metal/Cold	-	<b>LWW1-A21-55</b>	LWW1-B21-55	LWW1-C21-55
	•	LWW1-A51-55	LWW1-B51-55	LWW1-C51-55
Metal/Hot	-	LWW1-A22-55	LWW1-B22-55	LWW1-C22-55
	•	LWW1-A52-55	LWW1-B52-55	LWW1-C52-55
Plastic/Cold	-	LWW1-A23-55	LWW1-B23-55	LWW1-C23-55
	•	LWW1-A53-55	LWW1-B53-55	LWW1-C53-55
Plastic/Hot	-	LWW1-A24-55	LWW1-B24-55	LWW1-C24-55
	•	LWW1-A54-55	LWW1-B54-55	LWW1-C54-55



## Wall Mounted, Straight Pattern Dual 90° Water Valve Assembly Less Shank

- Solid brass straight valve body
- “Y” pattern wall flange with two valves
- Polished chrome plated finish
- 2-1/2” vandal proof cross handle
- 3/8” - 18 NPT female thread inlet



### Straight Nozzle

Handle/Index	Vacuum Breaker	Compression Cartridge	Ceramic Cartridge	Control-A-Flow Cartridge
Metal/Cold	–	LWV1-A11-60	LWV1-B11-60	LWV1-C11-60
	•	LWV1-A41-60	LWV1-B41-60	LWV1-C41-60
Metal/Hot	–	LWV1-A12-60	LWV1-B12-60	LWV1-C12-60
	•	LWV1-A42-60	LWV1-B42-60	LWV1-C42-60
Plastic/Cold	–	LWV1-A13-60	LWV1-B13-60	LWV1-C13-60
	•	LWV1-A43-60	LWV1-B43-60	LWV1-C43-60
Plastic/Hot	–	<b>LWV1-A14-60</b>	LWV1-B14-60	LWV1-C14-60
	•	LWV1-A44-60	LWV1-B44-60	LWV1-C44-60

### 30° Nozzle

Handle/Index	Vacuum Breaker	Compression Cartridge	Ceramic Cartridge	Control-A-Flow Cartridge
Metal/Cold	–	LWV1-A21-60	LWV1-B21-60	LWV1-C21-60
	•	LWV1-A51-60	LWV1-B51-60	LWV1-C51-60
Metal/Hot	–	LWV1-A22-60	LWV1-B22-60	LWV1-C22-60
	•	LWV1-A52-60	LWV1-B52-60	LWV1-C52-60
Plastic/Cold	–	LWV1-A23-60	LWV1-B23-60	LWV1-C23-60
	•	LWV1-A53-60	LWV1-B53-60	LWV1-C53-60
Plastic/Hot	–	LWV1-A24-60	LWV1-B24-60	LWV1-C24-60
	•	LWV1-A54-60	LWV1-B54-60	LWV1-C54-60

### Straight Nozzle With Aspirator

Handle/Index	Vacuum Breaker	Compression Cartridge	Ceramic Cartridge	Control-A-Flow Cartridge
Metal/Cold	–	LWV1-A31-60	LWV1-B31-60	LWV1-C31-60
	•	LWV1-A61-60	LWV1-B61-60	LWV1-C61-60
Metal/Hot	–	LWV1-A32-60	LWV1-B32-60	LWV1-C32-60
	•	LWV1-A62-60	LWV1-B62-60	LWV1-C62-60
Plastic/Cold	–	LWV1-A33-60	LWV1-B33-60	LWV1-C33-60
	•	LWV1-A63-60	LWV1-B63-60	LWV1-C63-60
Plastic/Hot	–	LWV1-A34-60	LWV1-B34-60	LWV1-C34-60
	•	LWV1-A64-60	LWV1-B64-60	LWV1-C64-60

## Wall Mounted, Straight Pattern Dual 90° Water Valve Assembly With Shank

- “Y” pattern wall flange with two valves
- Solid brass straight valve body
- Polished chrome plated finish
- 2-1/2” vandal proof cross handle
- 3/8” - 18 NPT male thread shank assembly



### Straight Nozzle

Handle/Index	Vacuum Breaker	Compression Cartridge	Ceramic Cartridge	Control-A-Flow Cartridge
Metal/Cold	–	<b>LWV1-A11-65</b>	LWV1-B11-65	LWV1-C11-65
	•	LWV1-A41-65	LWV1-B41-65	LWV1-C41-65
Metal/Hot	–	LWV1-A12-65	LWV1-B12-65	LWV1-C12-65
	•	LWV1-A42-65	LWV1-B42-65	LWV1-C42-65
Plastic/Cold	–	LWV1-A13-65	LWV1-B13-65	LWV1-C13-65
	•	LWV1-A43-65	LWV1-B43-65	LWV1-C43-65
Plastic/Hot	–	LWV1-A14-65	LWV1-B14-65	LWV1-C14-65
	•	LWV1-A44-65	LWV1-B44-65	LWV1-C44-65

### 30° Nozzle

Handle/Index	Vacuum Breaker	Compression Cartridge	Ceramic Cartridge	Control-A-Flow Cartridge
Metal/Cold	–	LWV1-A21-65	LWV1-B21-65	LWV1-C21-65
	•	LWV1-A51-65	LWV1-B51-65	LWV1-C51-65
Metal/Hot	–	LWV1-A22-65	LWV1-B22-65	LWV1-C22-65
	•	LWV1-A52-65	LWV1-B52-65	LWV1-C52-65
Plastic/Cold	–	LWV1-A23-65	LWV1-B23-65	LWV1-C23-65
	•	LWV1-A53-65	LWV1-B53-65	LWV1-C53-65
Plastic/Hot	–	LWV1-A24-65	LWV1-B24-65	LWV1-C24-65
	•	LWV1-A54-65	LWV1-B54-65	LWV1-C54-65

### Straight Nozzle With Aspirator

Handle/Index	Vacuum Breaker	Compression Cartridge	Ceramic Cartridge	Control-A-Flow Cartridge
Metal/Cold	–	LWV1-A31-65	LWV1-B31-65	LWV1-C31-65
	•	LWV1-A61-65	LWV1-B61-65	LWV1-C61-65
Metal/Hot	–	LWV1-A32-65	LWV1-B32-65	LWV1-C32-65
	•	LWV1-A62-65	LWV1-B62-65	LWV1-C62-65
Plastic/Cold	–	LWV1-A33-65	LWV1-B33-65	LWV1-C33-65
	•	LWV1-A63-65	LWV1-B63-65	LWV1-C63-65
Plastic/Hot	–	LWV1-A34-65	LWV1-B34-65	LWV1-C34-65
	•	LWV1-A64-65	LWV1-B64-65	LWV1-C64-65

## Angle Pattern Water Valve

- Solid brass angle valve body
- Polished chrome plated finish
- 2-1/2" vandal proof cross handle
- 3/8" - 18 NPT female thread inlet



### 30° Nozzle

Handle/ Index	Vacuum Breaker	Compression Cartridge	Ceramic Cartridge	Control-A-Flow Cartridge
Metal/Cold	–	LWW2-A21	LWW2-B21	LWW2-C21
	•	LWW2-A51	LWW2-B51	LWW2-C51
Metal/Hot	–	LWW2-A22	LWW2-B22	LWW2-C22
	•	LWW2-A52	LWW2-B52	LWW2-C52
Plastic/Cold	–	LWW2-A23	LWW2-B23	LWW2-C23
	•	LWW2-A53	LWW2-B53	LWW2-C53
Plastic/Hot	–	<b>LWW2-A24</b>	LWW2-B24	LWW2-C24
	•	LWW2-A54	LWW2-B54	LWW2-C54

### Straight Nozzle

Handle/ Index	Vacuum Breaker	Compression Cartridge	Ceramic Cartridge	Control-A-Flow Cartridge
Metal/Cold	–	LWW2-A11	LWW2-B11	LWW2-C11
	•	LWW2-A41	LWW2-B41	LWW2-C41
Metal/Hot	–	LWW2-A12	LWW2-B12	LWW2-C12
	•	LWW2-A42	LWW2-B42	LWW2-C42
Plastic/Cold	–	LWW2-A13	LWW2-B13	LWW2-C13
	•	LWW2-A43	LWW2-B43	LWW2-C43
Plastic/Hot	–	LWW2-A14	LWW2-B14	LWW2-C14
	•	LWW2-A44	LWW2-B44	LWW2-C44

### Straight Nozzle With Aspirator

Handle/ Index	Vacuum Breaker	Compression Cartridge	Ceramic Cartridge	Control-A-Flow Cartridge
Metal/Cold	–	<b>LWW2-A31</b>	LWW2-B31	LWW2-C31
	•	LWW2-A61	LWW2-B61	LWW2-C61
Metal/Hot	–	LWW2-A32	LWW2-B32	LWW2-C32
	•	LWW2-A62	LWW2-B62	LWW2-C62
Plastic/Cold	–	LWW2-A33	LWW2-B33	LWW2-C33
	•	LWW2-A63	LWW2-B63	LWW2-C63
Plastic/Hot	–	LWW2-A34	LWW2-B34	LWW2-C34
	•	LWW2-A64	LWW2-B64	LWW2-C64

## Overhead Mounted, Single Water Valve Assembly

- Solid brass turret with one outlet
- Solid brass straight valve body
- Polished chrome plated finish
- 2-1/2" vandal proof cross handle
- 3/8" - 18 NPT male thread shank assembly



### 30° Nozzle

Handle/ Index	Vacuum Breaker	Compression Cartridge	Ceramic Cartridge	Control-A-Flow Cartridge
Metal/Cold	–	LWW2-A21-10	LWW2-B21-10	LWW2-C21-10
	•	LWW2-A51-10	LWW2-B51-10	LWW2-C51-10
Metal/Hot	–	LWW2-A22-10	LWW2-B22-10	LWW2-C22-10
	•	LWW2-A52-10	LWW2-B52-10	LWW2-C52-10
Plastic/Cold	–	<b>LWW2-A23-10</b>	LWW2-B23-10	LWW2-C23-10
	•	LWW2-A53-10	LWW2-B53-10	LWW2-C53-10
Plastic/Hot	–	LWW2-A24-10	LWW2-B24-10	LWW2-C24-10
	•	LWW2-A54-10	LWW2-B54-10	LWW2-C54-10

### Straight Nozzle

Handle/ Index	Vacuum Breaker	Compression Cartridge	Ceramic Cartridge	Control-A-Flow Cartridge
Metal/Cold	–	LWW2-A11-10	LWW2-B11-10	LWW2-C11-10
	•	LWW2-A41-10	LWW2-B41-10	LWW2-C41-10
Metal/Hot	–	LWW2-A12-10	LWW2-B12-10	LWW2-C12-10
	•	LWW2-A42-10	LWW2-B42-10	LWW2-C42-10
Plastic/Cold	–	LWW2-A13-10	LWW2-B13-10	LWW2-C13-10
	•	LWW2-A43-10	LWW2-B43-10	LWW2-C43-10
Plastic/Hot	–	LWW2-A14-10	LWW2-B14-10	LWW2-C14-10
	•	LWW2-A44-10	LWW2-B44-10	LWW2-C44-10

### Straight Nozzle With Aspirator

Handle/ Index	Vacuum Breaker	Compression Cartridge	Ceramic Cartridge	Control-A-Flow Cartridge
Metal/Cold	–	LWW2-A31-10	LWW2-B31-10	LWW2-C31-10
	•	LWW2-A61-10	LWW2-B61-10	LWW2-C61-10
Metal/Hot	–	LWW2-A32-10	LWW2-B32-10	LWW2-C32-10
	•	LWW2-A62-10	LWW2-B62-10	LWW2-C62-10
Plastic/Cold	–	LWW2-A33-10	LWW2-B33-10	LWW2-C33-10
	•	LWW2-A63-10	LWW2-B63-10	LWW2-C63-10
Plastic/Hot	–	LWW2-A34-10	LWW2-B34-10	LWW2-C34-10
	•	LWW2-A64-10	LWW2-B64-10	LWW2-C64-10

## Overhead Mounted, Dual 90° Water Valve Assembly

- Solid brass turret with two 90° outlets
- Solid brass straight valve body
- Polished chrome plated finish
- 2-1/2" vandal proof cross handle
- 3/8" - 18 NPT male thread shank assembly



Straight Nozzle

Handle/Index	Vacuum Breaker	Compression Cartridge	Ceramic Cartridge	Control-A-Flow Cartridge
Metal/Cold	–	<b>LWV2-A11-20</b>	LWV2-B11-20	LWV2-C11-20
	•	LWV2-A41-20	LWV2-B41-20	LWV2-C41-20
Metal/Hot	–	LWV2-A12-20	LWV2-B12-20	LWV2-C12-20
	•	LWV2-A42-20	LWV2-B42-20	LWV2-C42-20
Plastic/Cold	–	LWV2-A13-20	LWV2-B13-20	LWV2-C13-20
	•	LWV2-A43-20	LWV2-B43-20	LWV2-C43-20
Plastic/Hot	–	LWV2-A14-20	LWV2-B14-20	LWV2-C14-20
	•	LWV2-A44-20	LWV2-B44-20	LWV2-C44-20

30° Nozzle

Handle/Index	Vacuum Breaker	Compression Cartridge	Ceramic Cartridge	Control-A-Flow Cartridge
Metal/Cold	–	LWV2-A21-20	LWV2-B21-20	LWV2-C21-20
	•	LWV2-A51-20	LWV2-B51-20	LWV2-C51-20
Metal/Hot	–	LWV2-A22-20	LWV2-B22-20	LWV2-C22-20
	•	LWV2-A52-20	LWV2-B52-20	LWV2-C52-20
Plastic/Cold	–	LWV2-A23-20	LWV2-B23-20	LWV2-C23-20
	•	LWV2-A53-20	LWV2-B53-20	LWV2-C53-20
Plastic/Hot	–	LWV2-A24-20	LWV2-B24-20	LWV2-C24-20
	•	LWV2-A54-20	LWV2-B54-20	LWV2-C54-20

Straight Nozzle With Aspirator

Handle/Index	Vacuum Breaker	Compression Cartridge	Ceramic Cartridge	Control-A-Flow Cartridge
Metal/Cold	–	LWV2-A31-20	LWV2-B31-20	LWV2-C31-20
	•	LWV2-A61-20	LWV2-B61-20	LWV2-C61-20
Metal/Hot	–	LWV2-A32-20	LWV2-B32-20	LWV2-C32-20
	•	LWV2-A62-20	LWV2-B62-20	LWV2-C62-20
Plastic/Cold	–	LWV2-A33-20	LWV2-B33-20	LWV2-C33-20
	•	LWV2-A63-20	LWV2-B63-20	LWV2-C63-20
Plastic/Hot	–	LWV2-A34-20	LWV2-B34-20	LWV2-C34-20
	•	LWV2-A64-20	LWV2-B64-20	LWV2-C64-20

## Overhead Mounted, Dual 180° Water Valve Assembly

- Solid brass turret with two 180° outlets
- Solid brass straight valve body
- Polished chrome plated finish
- 2-1/2" vandal proof cross handle
- 3/8" - 18 NPT male thread shank assembly



Straight Nozzle

Handle/Index	Vacuum Breaker	Compression Cartridge	Ceramic Cartridge	Control-A-Flow Cartridge
Metal/Cold	–	LWV2-A11-25	LWV2-B11-25	LWV2-C11-25
	•	LWV2-A41-25	LWV2-B41-25	LWV2-C41-25
Metal/Hot	–	LWV2-A12-25	LWV2-B12-25	LWV2-C12-25
	•	LWV2-A42-25	LWV2-B42-25	LWV2-C42-25
Plastic/Cold	–	<b>LWV2-A13-25</b>	LWV2-B13-25	LWV2-C13-25
	•	LWV2-A43-25	LWV2-B43-25	LWV2-C43-25
Plastic/Hot	–	LWV2-A14-25	LWV2-B14-25	LWV2-C14-25
	•	LWV2-A44-25	LWV2-B44-25	LWV2-C44-25

30° Nozzle

Handle/Index	Vacuum Breaker	Compression Cartridge	Ceramic Cartridge	Control-A-Flow Cartridge
Metal/Cold	–	LWV2-A21-25	LWV2-B21-25	LWV2-C21-25
	•	LWV2-A51-25	LWV2-B51-25	LWV2-C51-25
Metal/Hot	–	LWV2-A22-25	LWV2-B22-25	LWV2-C22-25
	•	LWV2-A52-25	LWV2-B52-25	LWV2-C52-25
Plastic/Cold	–	LWV2-A23-25	LWV2-B23-25	LWV2-C23-25
	•	LWV2-A53-25	LWV2-B53-25	LWV2-C53-25
Plastic/Hot	–	LWV2-A24-25	LWV2-B24-25	LWV2-C24-25
	•	LWV2-A54-25	LWV2-B54-25	LWV2-C54-25

Straight Nozzle With Aspirator

Handle/Index	Vacuum Breaker	Compression Cartridge	Ceramic Cartridge	Control-A-Flow Cartridge
Metal/Cold	–	LWV2-A31-25	LWV2-B31-25	LWV2-C31-25
	•	LWV2-A61-25	LWV2-B61-25	LWV2-C61-25
Metal/Hot	–	LWV2-A32-25	LWV2-B32-25	LWV2-C32-25
	•	LWV2-A62-25	LWV2-B62-25	LWV2-C62-25
Plastic/Cold	–	LWV2-A33-25	LWV2-B33-25	LWV2-C33-25
	•	LWV2-A63-25	LWV2-B63-25	LWV2-C63-25
Plastic/Hot	–	LWV2-A34-25	LWV2-B34-25	LWV2-C34-25
	•	LWV2-A64-25	LWV2-B64-25	LWV2-C64-25

## Overhead Mounted, Three Water Valve Assembly

- Solid brass turret with three outlets
- Solid brass angled valve body
- Polished chrome plated finish
- 2-1/2" vandal proof cross handle
- 3/8" - 18 NPT male thread shank assembly



### 30° Nozzle

Handle/Index	Vacuum Breaker	Compression Cartridge	Ceramic Cartridge	Control-A-Flow Cartridge
Metal/Cold	-	LWV2-A21-30	LWV2-B21-30	LWV2-C21-30
	•	LWV2-A51-30	LWV2-B51-30	LWV2-C51-30
Metal/Hot	-	LWV2-A22-30	LWV2-B22-30	LWV2-C22-30
	•	LWV2-A52-30	LWV2-B52-30	LWV2-C52-30
Plastic/Cold	-	LWV2-A23-30	LWV2-B23-30	LWV2-C23-30
	•	LWV2-A53-30	LWV2-B53-30	LWV2-C53-30
Plastic/Hot	-	LWV2-A24-30	LWV2-B24-30	LWV2-C24-30
	•	LWV2-A54-30	LWV2-B54-30	LWV2-C54-30

### Straight Nozzle

Handle/Index	Vacuum Breaker	Compression Cartridge	Ceramic Cartridge	Control-A-Flow Cartridge
Metal/Cold	-	LWV2-A11-30	LWV2-B11-30	LWV2-C11-30
	•	LWV2-A41-30	LWV2-B41-30	LWV2-C41-30
Metal/Hot	-	LWV2-A12-30	LWV2-B12-30	LWV2-C12-30
	•	<b>LWV2-A42-30</b>	LWV2-B42-30	LWV2-C42-30
Plastic/Cold	-	LWV2-A13-30	LWV2-B13-30	LWV2-C13-30
	•	LWV2-A43-30	LWV2-B43-30	LWV2-C43-30
Plastic/Hot	-	LWV2-A14-30	LWV2-B14-30	LWV2-C14-30
	•	LWV2-A44-30	LWV2-B44-30	LWV2-C44-30

### Straight Nozzle With Aspirator

Handle/Index	Vacuum Breaker	Compression Cartridge	Ceramic Cartridge	Control-A-Flow Cartridge
Metal/Cold	-	LWV2-A31-30	LWV2-B31-30	LWV2-C31-30
	•	LWV2-A61-30	LWV2-B61-30	LWV2-C61-30
Metal/Hot	-	LWV2-A32-30	LWV2-B32-30	LWV2-C32-30
	•	LWV2-A62-30	LWV2-B62-30	LWV2-C62-30
Plastic/Cold	-	LWV2-A33-30	LWV2-B33-30	LWV2-C33-30
	•	LWV2-A63-30	LWV2-B63-30	LWV2-C63-30
Plastic/Hot	-	LWV2-A34-30	LWV2-B34-30	LWV2-C34-30
	•	LWV2-A64-30	LWV2-B64-30	LWV2-C64-30

## Overhead Mounted, Four Water Valve Assembly

- Solid brass turret with four outlets
- Solid brass angled valve body
- Polished chrome plated finish
- 2-1/2" vandal proof cross handle
- 3/8" - 18 NPT male thread shank assembly



### 30° Nozzle

Handle/Index	Vacuum Breaker	Compression Cartridge	Ceramic Cartridge	Control-A-Flow Cartridge
Metal/Cold	-	LWV2-A21-40	LWV2-B21-40	LWV2-C21-40
	•	LWV2-A51-40	LWV2-B51-40	LWV2-C51-40
Metal/Hot	-	LWV2-A22-40	LWV2-B22-40	LWV2-C22-40
	•	LWV2-A52-40	LWV2-B52-40	LWV2-C52-40
Plastic/Cold	-	LWV2-A23-40	LWV2-B23-40	LWV2-C23-40
	•	LWV2-A53-40	LWV2-B53-40	LWV2-C53-40
Plastic/Hot	-	LWV2-A24-40	LWV2-B24-40	LWV2-C24-40
	•	LWV2-A54-40	LWV2-B54-40	LWV2-C54-40

### Straight Nozzle

Handle/Index	Vacuum Breaker	Compression Cartridge	Ceramic Cartridge	Control-A-Flow Cartridge
Metal/Cold	-	<b>LWV2-A11-40</b>	LWV2-B11-40	LWV2-C11-40
	•	LWV2-A41-40	LWV2-B41-40	LWV2-C41-40
Metal/Hot	-	LWV2-A12-40	LWV2-B12-40	LWV2-C12-40
	•	LWV2-A42-40	LWV2-B42-40	LWV2-C42-40
Plastic/Cold	-	LWV2-A13-40	LWV2-B13-40	LWV2-C13-40
	•	LWV2-A43-40	LWV2-B43-40	LWV2-C43-40
Plastic/Hot	-	LWV2-A14-40	LWV2-B14-40	LWV2-C14-40
	•	LWV2-A44-40	LWV2-B44-40	LWV2-C44-40

### Straight Nozzle With Aspirator

Handle/Index	Vacuum Breaker	Compression Cartridge	Ceramic Cartridge	Control-A-Flow Cartridge
Metal/Cold	-	LWV2-A31-40	LWV2-B31-40	LWV2-C31-40
	•	LWV2-A61-40	LWV2-B61-40	LWV2-C61-40
Metal/Hot	-	LWV2-A32-40	LWV2-B32-40	LWV2-C32-40
	•	LWV2-A62-40	LWV2-B62-40	LWV2-C62-40
Plastic/Cold	-	LWV2-A33-40	LWV2-B33-40	LWV2-C33-40
	•	LWV2-A63-40	LWV2-B63-40	LWV2-C63-40
Plastic/Hot	-	LWV2-A34-40	LWV2-B34-40	LWV2-C34-40
	•	LWV2-A64-40	LWV2-B64-40	LWV2-C64-40

## Overhead Mounted, Angle Pattern Single Water Valve Assembly Less Shank

- Solid brass angled valve body
- Wall flange
- Polished chrome plated finish
- 2-1/2" vandal proof cross handle
- 3/8" - 18 NPT female thread inlet



### 30° Nozzle

Handle/Index	Vacuum Breaker	Compression Cartridge	Ceramic Cartridge	Control-A-Flow Cartridge
Metal/Cold	-	LWV2-A21-50	LWV2-B21-50	LWV2-C21-50
	•	LWV2-A51-50	LWV2-B51-50	LWV2-C51-50
Metal/Hot	-	LWV2-A22-50	LWV2-B22-50	LWV2-C22-50
	•	LWV2-A52-50	LWV2-B52-50	LWV2-C52-50
Plastic/Cold	-	LWV2-A23-50	LWV2-B23-50	LWV2-C23-50
	•	LWV2-A53-50	LWV2-B53-50	LWV2-C53-50
Plastic/Hot	-	LWV2-A24-50	LWV2-B24-50	LWV2-C24-50
	•	LWV2-A54-50	LWV2-B54-50	LWV2-C54-50

### Straight Nozzle

Handle/Index	Vacuum Breaker	Compression Cartridge	Ceramic Cartridge	Control-A-Flow Cartridge
Metal/Cold	-	LWV2-A11-50	LWV2-B11-50	LWV2-C11-50
	•	LWV2-A41-50	LWV2-B41-50	LWV2-C41-50
Metal/Hot	-	LWV2-A12-50	LWV2-B12-50	LWV2-C12-50
	•	<b>LWV2-A42-50</b>	LWV2-B42-50	LWV2-C42-50
Plastic/Cold	-	LWV2-A13-50	LWV2-B13-50	LWV2-C13-50
	•	LWV2-A43-50	LWV2-B43-50	LWV2-C43-50
Plastic/Hot	-	LWV2-A14-50	LWV2-B14-50	LWV2-C14-50
	•	LWV2-A44-50	LWV2-B44-50	LWV2-C44-50

### Straight Nozzle With Aspirator

Handle/Index	Vacuum Breaker	Compression Cartridge	Ceramic Cartridge	Control-A-Flow Cartridge
Metal/Cold	-	LWV2-A31-50	LWV2-B31-50	LWV2-C31-50
	•	LWV2-A61-50	LWV2-B61-50	LWV2-C61-50
Metal/Hot	-	LWV2-A32-50	LWV2-B32-50	LWV2-C32-50
	•	LWV2-A62-50	LWV2-B62-50	LWV2-C62-50
Plastic/Cold	-	LWV2-A33-50	LWV2-B33-50	LWV2-C33-50
	•	LWV2-A63-50	LWV2-B63-50	LWV2-C63-50
Plastic/Hot	-	LWV2-A34-50	LWV2-B34-50	LWV2-C34-50
	•	LWV2-A64-50	LWV2-B64-50	LWV2-C64-50

## Overhead Mounted, Angle Pattern Single Water Valve Assembly With Shank

- Wall flange
- Solid brass angled valve body
- Polished chrome plated finish
- 2-1/2" vandal proof cross handle
- 3/8" - 18 NPT male thread shank assembly



### 30° Nozzle

Handle/Index	Vacuum Breaker	Compression Cartridge	Ceramic Cartridge	Control-A-Flow Cartridge
Metal/Cold	-	LWV2-A21-55	LWV2-B21-55	LWV2-C21-55
	•	LWV2-A51-55	LWV2-B51-55	LWV2-C51-55
Metal/Hot	-	LWV2-A22-55	LWV2-B22-55	LWV2-C22-55
	•	LWV2-A52-55	LWV2-B52-55	LWV2-C52-55
Plastic/Cold	-	LWV2-A23-55	<b>LWV2-B23-55</b>	LWV2-C23-55
	•	LWV2-A53-55	LWV2-B53-55	LWV2-C53-55
Plastic/Hot	-	LWV2-A24-55	LWV2-B24-55	LWV2-C24-55
	•	LWV2-A54-55	LWV2-B54-55	LWV2-C54-55

### Straight Nozzle

Handle/Index	Vacuum Breaker	Compression Cartridge	Ceramic Cartridge	Control-A-Flow Cartridge
Metal/Cold	-	LWV2-A11-55	LWV2-B11-55	LWV2-C11-55
	•	LWV2-A41-55	LWV2-B41-55	LWV2-C41-55
Metal/Hot	-	LWV2-A12-55	LWV2-B12-55	LWV2-C12-55
	•	LWV2-A42-55	LWV2-B42-55	LWV2-C42-55
Plastic/Cold	-	LWV2-A13-55	LWV2-B13-55	LWV2-C13-55
	•	LWV2-A43-55	LWV2-B43-55	LWV2-C43-55
Plastic/Hot	-	LWV2-A14-55	LWV2-B14-55	LWV2-C14-55
	•	LWV2-A44-55	LWV2-B44-55	LWV2-C44-55

### Straight Nozzle With Aspirator

Handle/Index	Vacuum Breaker	Compression Cartridge	Ceramic Cartridge	Control-A-Flow Cartridge
Metal/Cold	-	LWV2-A31-55	LWV2-B31-55	LWV2-C31-55
	•	LWV2-A61-55	LWV2-B61-55	LWV2-C61-55
Metal/Hot	-	LWV2-A32-55	LWV2-B32-55	LWV2-C32-55
	•	LWV2-A62-55	LWV2-B62-55	LWV2-C62-55
Plastic/Cold	-	LWV2-A33-55	LWV2-B33-55	LWV2-C33-55
	•	LWV2-A63-55	LWV2-B63-55	LWV2-C63-55
Plastic/Hot	-	LWV2-A34-55	LWV2-B34-55	LWV2-C34-55
	•	LWV2-A64-55	LWV2-B64-55	LWV2-C64-55

## Overhead Mounted, Angle Pattern Dual 90° Water Valve Assembly Less Shank

- Solid brass angled valve body
- “Y” pattern wall flange with two valves
- Polished chrome plated finish
- 2-1/2” vandal proof cross handle
- 3/8” - 18 NPT female thread inlet



Straight Nozzle

Handle/Index	Vacuum Breaker	Compression Cartridge	Ceramic Cartridge	Control-A-Flow Cartridge
Metal/Cold	–	LWW2-A11-60	LWW2-B11-60	LWW2-C11-60
	•	LWW2-A41-60	LWW2-B41-60	LWW2-C41-60
Metal/Hot	–	LWW2-A12-60	LWW2-B12-60	LWW2-C12-60
	•	LWW2-A42-60	LWW2-B42-60	LWW2-C42-60
Plastic/Cold	–	LWW2-A13-60	LWW2-B13-60	LWW2-C13-60
	•	LWW2-A43-60	LWW2-B43-60	LWW2-C43-60
Plastic/Hot	–	<b>LWW2-A14-60</b>	LWW2-B14-60	LWW2-C14-60
	•	LWW2-A44-60	LWW2-B44-60	LWW2-C44-60

30° Nozzle

Handle/Index	Vacuum Breaker	Compression Cartridge	Ceramic Cartridge	Control-A-Flow Cartridge
Metal/Cold	–	LWW2-A21-60	LWW2-B21-60	LWW2-C21-60
	•	LWW2-A51-60	LWW2-B51-60	LWW2-C51-60
Metal/Hot	–	LWW2-A22-60	LWW2-B22-60	LWW2-C22-60
	•	LWW2-A52-60	LWW2-B52-60	LWW2-C52-60
Plastic/Cold	–	LWW2-A23-60	LWW2-B23-60	LWW2-C23-60
	•	LWW2-A53-60	LWW2-B53-60	LWW2-C53-60
Plastic/Hot	–	LWW2-A24-60	LWW2-B24-60	LWW2-C24-60
	•	LWW2-A54-60	LWW2-B54-60	LWW2-C54-60

Straight Nozzle With Aspirator

Handle/Index	Vacuum Breaker	Compression Cartridge	Ceramic Cartridge	Control-A-Flow Cartridge
Metal/Cold	–	LWW2-A31-60	LWW2-B31-60	LWW2-C31-60
	•	LWW2-A61-60	LWW2-B61-60	LWW2-C61-60
Metal/Hot	–	LWW2-A32-60	LWW2-B32-60	LWW2-C32-60
	•	LWW2-A62-60	LWW2-B62-60	LWW2-C62-60
Plastic/Cold	–	LWW2-A33-60	LWW2-B33-60	LWW2-C33-60
	•	LWW2-A63-60	LWW2-B63-60	LWW2-C63-60
Plastic/Hot	–	LWW2-A34-60	LWW2-B34-60	LWW2-C34-60
	•	LWW2-A64-60	LWW2-B64-60	LWW2-C64-60

## Overhead Mounted, Angle Pattern Dual 90° Water Valve Assembly With Shank

- “Y” pattern wall flange with two valves
- Solid brass straight valve body
- Polished chrome plated finish
- 2-1/2” vandal proof cross handle
- 3/8” - 18 NPT male thread shank assembly



Straight Nozzle

Handle/Index	Vacuum Breaker	Compression Cartridge	Ceramic Cartridge	Control-A-Flow Cartridge
Metal/Cold	–	<b>LWW2-A11-65</b>	LWW2-B11-65	LWW2-C11-65
	•	LWW2-A41-65	LWW2-B41-65	LWW2-C41-65
Metal/Hot	–	LWW2-A12-65	LWW2-B12-65	LWW2-C12-65
	•	LWW2-A42-65	LWW2-B42-65	LWW2-C42-65
Plastic/Cold	–	LWW2-A13-65	LWW2-B13-65	LWW2-C13-65
	•	LWW2-A43-65	LWW2-B43-65	LWW2-C43-65
Plastic/Hot	–	LWW2-A14-65	LWW2-B14-65	LWW2-C14-65
	•	LWW2-A44-65	LWW2-B44-65	LWW2-C44-65

30° Nozzle

Handle/Index	Vacuum Breaker	Compression Cartridge	Ceramic Cartridge	Control-A-Flow Cartridge
Metal/Cold	–	LWW2-A21-65	LWW2-B21-65	LWW2-C21-65
	•	LWW2-A51-65	LWW2-B51-65	LWW2-C51-65
Metal/Hot	–	LWW2-A22-65	LWW2-B22-65	LWW2-C22-65
	•	LWW2-A52-65	LWW2-B52-65	LWW2-C52-65
Plastic/Cold	–	LWW2-A23-65	LWW2-B23-65	LWW2-C23-65
	•	LWW2-A53-65	LWW2-B53-65	LWW2-C53-65
Plastic/Hot	–	LWW2-A24-65	LWW2-B24-65	LWW2-C24-65
	•	LWW2-A54-65	LWW2-B54-65	LWW2-C54-65

Straight Nozzle With Aspirator

Handle/Index	Vacuum Breaker	Compression Cartridge	Ceramic Cartridge	Control-A-Flow Cartridge
Metal/Cold	–	LWW2-A31-65	LWW2-B31-65	LWW2-C31-65
	•	LWW2-A61-65	LWW2-B61-65	LWW2-C61-65
Metal/Hot	–	LWW2-A32-65	LWW2-B32-65	LWW2-C32-65
	•	LWW2-A62-65	LWW2-B62-65	LWW2-C62-65
Plastic/Cold	–	LWW2-A33-65	LWW2-B33-65	LWW2-C33-65
	•	LWW2-A63-65	LWW2-B63-65	LWW2-C63-65
Plastic/Hot	–	LWW2-A34-65	LWW2-B34-65	LWW2-C34-65
	•	LWW2-A64-65	LWW2-B64-65	LWW2-C64-65

## Hose Bibb Water Valve Less Shank

- Solid brass straight valve body
- Polished chrome plated finish
- 2-1/2" vandal proof cross handle
- 3/8" - 18 NPT female thread inlet



### Straight Nozzle

Handle/Index	Vacuum Breaker	Compression Cartridge	Ceramic Cartridge	Control-A-Flow Cartridge
Metal/Cold	–	LWV3-A11	LWV3-B11	LWV3-C11
	•	LWV3-A41	LWV3-B41	LWV3-C41
Metal/Hot	–	LWV3-A12	LWV3-B12	LWV3-C12
	•	LWV3-A42	LWV3-B42	LWV3-C42
Plastic/Cold	–	<b>LWV3-A13</b>	LWV3-B13	LWV3-C13
	•	LWV3-A43	LWV3-B43	LWV3-C43
Plastic/Hot	–	LWV3-A14	LWV3-B14	LWV3-C14
	•	LWV3-A44	LWV3-B44	LWV3-C44

### 30° Nozzle

Handle/Index	Vacuum Breaker	Compression Cartridge	Ceramic Cartridge	Control-A-Flow Cartridge
Metal/Cold	–	LWV3-A21	LWV3-B21	LWV3-C21
	•	LWV3-A51	LWV3-B51	LWV3-C51
Metal/Hot	–	LWV3-A22	LWV3-B22	LWV3-C22
	•	LWV3-A52	LWV3-B52	LWV3-C52
Plastic/Cold	–	LWV3-A23	LWV3-B23	LWV3-C23
	•	LWV3-A53	LWV3-B53	LWV3-C53
Plastic/Hot	–	LWV3-A24	LWV3-B24	LWV3-C24
	•	LWV3-A44	LWV3-B44	LWV3-C44

### Straight Nozzle With Aspirator

Handle/Index	Vacuum Breaker	Compression Cartridge	Ceramic Cartridge	Control-A-Flow Cartridge
Metal/Cold	–	LWV3-A31	LWV3-B31	LWV3-C31
	•	LWV3-A61	LWV3-B61	LWV3-C61
Metal/Hot	–	LWV3-A32	LWV3-B32	LWV3-C32
	•	LWV3-A62	LWV3-B62	LWV3-C62
Plastic/Cold	–	LWV3-A33	LWV3-B33	LWV3-C33
	•	LWV3-A63	LWV3-B63	LWV3-C63
Plastic/Hot	–	LWV3-A34	LWV3-B34	LWV3-C34
	•	LWV3-A64	LWV3-B64	LWV3-C64

## Hose Bibb Water Valve With Shank

- Solid brass straight valve body
- Polished chrome plated finish
- 2-1/2" vandal proof cross handle
- 3/8" - 18 NPT male thread shank assembly



### Straight Nozzle

Handle/Index	Vacuum Breaker	Compression Cartridge	Ceramic Cartridge	Control-A-Flow Cartridge
Metal/Cold	–	LWV4-A11	LWV4-B11	LWV4-C11
	•	LWV4-A41	LWV4-B41	LWV4-C41
Metal/Hot	–	LWV4-A12	LWV4-B12	LWV4-C12
	•	LWV4-A42	LWV4-B42	LWV4-C42
Plastic/Cold	–	LWV4-A13	LWV4-B13	LWV4-C13
	•	LWV4-A43	LWV4-B43	LWV4-C43
Plastic/Hot	–	LWV4-A14	LWV4-B14	LWV4-C14
	•	LWV4-A44	LWV4-B44	LWV4-C44

### 30° Nozzle

Handle/Index	Vacuum Breaker	Compression Cartridge	Ceramic Cartridge	Control-A-Flow Cartridge
Metal/Cold	–	LWV4-A21	LWV4-B21	LWV4-C21
	•	LWV4-A51	LWV4-B51	LWV4-C51
Metal/Hot	–	<b>LWV4-A22</b>	LWV4-B22	LWV4-C22
	•	LWV4-A52	LWV4-B52	LWV4-C52
Plastic/Cold	–	LWV4-A23	LWV4-B23	LWV4-C23
	•	LWV4-A53	LWV4-B53	LWV4-C53
Plastic/Hot	–	LWV4-A24	LWV4-B24	LWV4-C24
	•	LWV4-A54	LWV4-B54	LWV4-C54

### Straight Nozzle With Aspirator

Handle/Index	Vacuum Breaker	Compression Cartridge	Ceramic Cartridge	Control-A-Flow Cartridge
Metal/Cold	–	LWV4-A31	LWV4-B31	LWV4-C31
	•	LWV4-A61	LWV4-B61	LWV4-C61
Metal/Hot	–	LWV4-A32	LWV4-B32	LWV4-C32
	•	LWV4-A62	LWV4-B62	LWV4-C62
Plastic/Cold	–	LWV4-A33	LWV4-B33	LWV4-C33
	•	LWV4-A63	LWV4-B63	LWV4-C63
Plastic/Hot	–	LWV4-A34	LWV4-B34	LWV4-C34
	•	LWV4-A64	LWV4-B64	LWV4-C64

## How to build and order a Chicago Faucets laboratory water single faucet.

Chicago Faucets makes it easy for you to build a faucet that meets your exact requirements. You can reference the charts on the following pages, or you can build your own faucet by choosing the components below to configure your model number.

# LWS A-B C D-E

(Lab Water Single)

### Base

A



Deck Mount Right-Hand Operation



Deck Mount Left-Hand Operation



Deck Mount Back-Mount Handle



Wall Mount



Wall Mount w/ Shanks

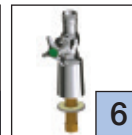

Turret with Front-Mount Handle

### Cartridge

B



Compression



Ceramic



Control-A-Flow

### EXAMPLE



### LWS4-B31-5

Wall mount, ceramic cartridge, straight nozzle with aspirator, metal handle with cold index, and 5-1/4" gooseneck spout with vacuum breaker.

### Outlet

C



Straight Nozzle



2.2 GPM Aerated Outlet



Straight Nozzle w/ aspirator

### Handles

D



Metal Cross, "CW" Index



Metal Cross, "HW" Index

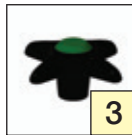

Plastic Cross, "CW" Index

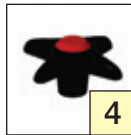

Plastic Cross, "HW" Index



Wristblade, Cold Index



Wristblade, Hot Index

### Spouts

E



5-1/4" Rigid/Swing Gooseneck



8" Rigid/Swing Gooseneck



5-1/4" Rigid/Swing Gooseneck w/ Vacuum Breaker



8" Rigid/Swing Gooseneck w/ Vacuum Breaker



5-1/4" Rigid Gooseneck w/ Vacuum Breaker

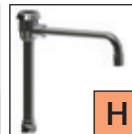

8" Rigid Gooseneck w/ Vacuum Breaker



## Deck Mounted, Right-Hand Operation, 5-1/4" Gooseneck Spout

- Solid brass construction
- Polished chrome plated finish
- 1/2" NPSM supply inlet with coupling nut for 3/8" or 1/2" flexible riser



### 2.2 GPM Aerated Outlet

Handle/Index	Compression Cartridge	Ceramic Cartridge	Control-A-Flow Cartridge
Metal Cross/Cold	LWS1-A21-A	LWS1-B21-A	LWS1-C21-A
Metal Cross/Hot	LWS1-A22-A	LWS1-B22-A	LWS1-C22-A
Plastic Cross/Cold	LWS1-A23-A	LWS1-B23-A	LWS1-C23-A
Plastic Cross/Hot	LWS1-A24-A	LWS1-B24-A	LWS1-C24-A
Wristblade/Cold	LWS1-A25-A	LWS1-B25-A	LWS1-C25-A
Wristblade/Hot	LWS1-A26-A	LWS1-B26-A	LWS1-C26-A

### Straight Nozzle

Handle/Index	Compression Cartridge	Ceramic Cartridge	Control-A-Flow Cartridge
Metal Cross/Cold	<b>LWS1-A11-A</b>	LWS1-B11-A	LWS1-C11-A
Metal Cross/Hot	LWS1-A12-A	LWS1-B12-A	LWS1-C12-A
Plastic Cross/Cold	LWS1-A13-A	LWS1-B13-A	LWS1-C13-A
Plastic Cross/Hot	LWS1-A14-A	LWS1-B14-A	LWS1-C14-A
Wristblade/Cold	LWS1-A15-A	LWS1-B15-A	LWS1-C15-A
Wristblade/Hot	LWS1-A16-A	LWS1-B16-A	LWS1-C16-A

### Straight Nozzle With Aspirator

Handle/Index	Compression Cartridge	Ceramic Cartridge	Control-A-Flow Cartridge
Metal Cross/Cold	LWS1-A31-A	LWS1-B31-A	LWS1-C31-A
Metal Cross/Hot	LWS1-A32-A	LWS1-B32-A	LWS1-C32-A
Plastic Cross/Cold	LWS1-A33-A	LWS1-B33-A	LWS1-C33-A
Plastic Cross/Hot	LWS1-A34-A	LWS1-B34-A	LWS1-C34-A
Wristblade/Cold	LWS1-A35-A	LWS1-B35-A	LWS1-C35-A
Wristblade/Hot	LWS1-A36-A	LWS1-B36-A	LWS1-C36-A

## Deck Mounted, Right-Hand Operation, 8" Gooseneck Spout

- Solid brass construction
- Polished chrome plated finish
- 1/2" NPSM supply inlet with coupling nut for 3/8" or 1/2" flexible riser



### 2.2 GPM Aerated Outlet

Handle/Index	Compression Cartridge	Ceramic Cartridge	Control-A-Flow Cartridge
Metal Cross/Cold	LWS1-A21-B	LWS1-B21-B	LWS1-C21-B
Metal Cross/Hot	<b>LWS1-A22-B</b>	LWS1-B22-B	LWS1-C22-B
Plastic Cross/Cold	LWS1-A23-B	LWS1-B23-B	LWS1-C23-B
Plastic Cross/Hot	LWS1-A24-B	LWS1-B24-B	LWS1-C24-B
Wristblade/Cold	LWS1-A25-B	LWS1-B25-B	LWS1-C25-B
Wristblade/Hot	LWS1-A26-B	LWS1-B26-B	LWS1-C26-B

### Straight Nozzle

Handle/Index	Compression Cartridge	Ceramic Cartridge	Control-A-Flow Cartridge
Metal Cross/Cold	LWS1-A11-B	LWS1-B11-B	LWS1-C11-B
Metal Cross/Hot	LWS1-A12-B	LWS1-B12-B	LWS1-C12-B
Plastic Cross/Cold	LWS1-A13-B	LWS1-B13-B	LWS1-C13-B
Plastic Cross/Hot	LWS1-A14-B	LWS1-B14-B	LWS1-C14-B
Wristblade/Cold	LWS1-A15-B	LWS1-B15-B	LWS1-C15-B
Wristblade/Hot	LWS1-A16-B	LWS1-B16-B	LWS1-C16-B

### Straight Nozzle With Aspirator

Handle/Index	Compression Cartridge	Ceramic Cartridge	Control-A-Flow Cartridge
Metal Cross/Cold	LWS1-A31-B	LWS1-B31-B	LWS1-C31-B
Metal Cross/Hot	LWS1-A32-B	LWS1-B32-B	LWS1-C32-B
Plastic Cross/Cold	LWS1-A33-B	LWS1-B33-B	LWS1-C33-B
Plastic Cross/Hot	LWS1-A34-B	LWS1-B34-B	LWS1-C34-B
Wristblade/Cold	LWS1-A35-B	LWS1-B35-B	LWS1-C35-B
Wristblade/Hot	LWS1-A36-B	LWS1-B36-B	LWS1-C36-B

## Deck Mounted, Right-Hand Operation, 5-1/4" Gooseneck Spout with Vacuum Breaker

- Solid brass construction
- Polished chrome plated finish
- 1/2" NPSM supply inlet with coupling nut for 3/8" or 1/2" flexible riser



### 2.2 GPM Aerated Outlet

Handle/Index	Compression Cartridge	Ceramic Cartridge	Control-A-Flow Cartridge
Metal Cross/Cold	LWS1-A21-E	LWS1-B21-E	LWS1-C21-E
Metal Cross/Hot	LWS1-A22-E	LWS1-B22-E	LWS1-C22-E
Plastic Cross/Cold	LWS1-A23-E	<b>LWS1-B23-E</b>	LWS1-C23-E
Plastic Cross/Hot	LWS1-A24-E	LWS1-B24-E	LWS1-C24-E
Wristblade/Cold	LWS1-A25-E	LWS1-B25-E	LWS1-C25-E
Wristblade/Hot	LWS1-A26-E	LWS1-B26-E	LWS1-C26-E

### Straight Nozzle

Handle/Index	Compression Cartridge	Ceramic Cartridge	Control-A-Flow Cartridge
Metal Cross/Cold	LWS1-A11-E	LWS1-B11-E	LWS1-C11-E
Metal Cross/Hot	LWS1-A12-E	LWS1-B12-E	LWS1-C12-E
Plastic Cross/Cold	LWS1-A13-E	LWS1-B13-E	LWS1-C13-E
Plastic Cross/Hot	LWS1-A14-E	LWS1-B14-E	LWS1-C14-E
Wristblade/Cold	LWS1-A15-E	LWS1-B15-E	LWS1-C15-E
Wristblade/Hot	LWS1-A16-E	LWS1-B16-E	LWS1-C16-E

### Straight Nozzle With Aspirator

Handle/Index	Compression Cartridge	Ceramic Cartridge	Control-A-Flow Cartridge
Metal Cross/Cold	LWS1-A31-E	LWS1-B31-E	LWS1-C31-E
Metal Cross/Hot	LWS1-A32-E	LWS1-B32-E	LWS1-C32-E
Plastic Cross/Cold	LWS1-A33-E	LWS1-B33-E	LWS1-C33-E
Plastic Cross/Hot	LWS1-A34-E	LWS1-B34-E	LWS1-C34-E
Wristblade/Cold	LWS1-A35-E	LWS1-B35-E	LWS1-C35-E
Wristblade/Hot	LWS1-A36-E	LWS1-B36-E	LWS1-C36-E

## Deck Mounted, Right-Hand Operation, 8" Gooseneck Spout with Vacuum Breaker

- Solid brass construction
- Polished chrome plated finish
- 1/2" NPSM supply inlet with coupling nut for 3/8" or 1/2" flexible riser



### 2.2 GPM Aerated Outlet

Handle/Index	Compression Cartridge	Ceramic Cartridge	Control-A-Flow Cartridge
Metal Cross/Cold	LWS1-A21-F	LWS1-B21-F	LWS1-C21-F
Metal Cross/Hot	LWS1-A22-F	<b>LWS1-B22-F</b>	LWS1-C22-F
Plastic Cross/Cold	LWS1-A23-F	LWS1-B23-F	LWS1-C23-F
Plastic Cross/Hot	LWS1-A24-F	LWS1-B24-F	LWS1-C24-F
Wristblade/Cold	LWS1-A25-F	LWS1-B25-F	LWS1-C25-F
Wristblade/Hot	LWS1-A26-F	LWS1-B26-F	LWS1-C26-F

### Straight Nozzle

Handle/Index	Compression Cartridge	Ceramic Cartridge	Control-A-Flow Cartridge
Metal Cross/Cold	LWS1-A11-F	LWS1-B11-F	LWS1-C11-F
Metal Cross/Hot	LWS1-A12-F	LWS1-B12-F	LWS1-C12-F
Plastic Cross/Cold	LWS1-A13-F	LWS1-B13-F	LWS1-C13-F
Plastic Cross/Hot	LWS1-A14-F	LWS1-B14-F	LWS1-C14-F
Wristblade/Cold	LWS1-A15-F	LWS1-B15-F	LWS1-C15-F
Wristblade/Hot	LWS1-A16-F	LWS1-B16-F	LWS1-C16-F

### Straight Nozzle With Aspirator

Handle/Index	Compression Cartridge	Ceramic Cartridge	Control-A-Flow Cartridge
Metal Cross/Cold	LWS1-A31-F	LWS1-B31-F	LWS1-C31-F
Metal Cross/Hot	LWS1-A32-F	LWS1-B32-F	LWS1-C32-F
Plastic Cross/Cold	LWS1-A33-F	LWS1-B33-F	LWS1-C33-F
Plastic Cross/Hot	LWS1-A34-F	LWS1-B34-F	LWS1-C34-F
Wristblade/Cold	LWS1-A35-F	LWS1-B35-F	LWS1-C35-F
Wristblade/Hot	LWS1-A36-F	LWS1-B36-F	LWS1-C36-F

## Deck Mounted, Right-Hand Operation, 5-1/4" Rigid Spout with Vacuum Breaker

- Solid brass construction
- Polished chrome plated finish
- 1/2" NPSM supply inlet with coupling nut for 3/8" or 1/2" flexible riser



### 2.2 GPM Aerated Outlet

Handle/Index	Compression Cartridge	Ceramic Cartridge	Control-A-Flow Cartridge
Metal Cross/Cold	LWS1-A21-G	LWS1-B21-G	LWS1-C21-G
Metal Cross/Hot	LWS1-A22-G	LWS1-B22-G	LWS1-C22-G
Plastic Cross/Cold	LWS1-A23-G	LWS1-B23-G	LWS1-C23-G
Plastic Cross/Hot	LWS1-A24-G	LWS1-B24-G	LWS1-C24-G
Wristblade/Cold	LWS1-A25-G	LWS1-B25-G	LWS1-C25-G
Wristblade/Hot	LWS1-A26-G	LWS1-B26-G	LWS1-C26-G

### Straight Nozzle

Handle/Index	Compression Cartridge	Ceramic Cartridge	Control-A-Flow Cartridge
Metal Cross/Cold	LWS1-A11-G	LWS1-B11-G	LWS1-C11-G
Metal Cross/Hot	LWS1-A12-G	LWS1-B12-G	LWS1-C12-G
Plastic Cross/Cold	LWS1-A13-G	LWS1-B13-G	LWS1-C13-G
Plastic Cross/Hot	LWS1-A14-G	LWS1-B14-G	LWS1-C14-G
Wristblade/Cold	LWS1-A15-G	<b>LWS1-B15-G</b>	LWS1-C15-G
Wristblade/Hot	LWS1-A16-G	LWS1-B16-G	LWS1-C16-G

### Straight Nozzle With Aspirator

Handle/Index	Compression Cartridge	Ceramic Cartridge	Control-A-Flow Cartridge
Metal Cross/Cold	LWS1-A31-G	LWS1-B31-G	LWS1-C31-G
Metal Cross/Hot	LWS1-A32-G	LWS1-B32-G	LWS1-C32-G
Plastic Cross/Cold	LWS1-A33-G	LWS1-B33-G	LWS1-C33-G
Plastic Cross/Hot	LWS1-A34-G	LWS1-B34-G	LWS1-C34-G
Wristblade/Cold	LWS1-A35-G	LWS1-B35-G	LWS1-C35-G
Wristblade/Hot	LWS1-A36-G	LWS1-B36-G	LWS1-C36-G

## Deck Mounted, Right-Hand Operation, 8" Rigid Spout with Vacuum Breaker

- Solid brass construction
- Polished chrome plated finish
- 1/2" NPSM supply inlet with coupling nut for 3/8" or 1/2" flexible riser



### 2.2 GPM Aerated Outlet

Handle/Index	Compression Cartridge	Ceramic Cartridge	Control-A-Flow Cartridge
Metal Cross/Cold	LWS1-A21-H	LWS1-B21-H	LWS1-C21-H
Metal Cross/Hot	LWS1-A22-H	LWS1-B22-H	LWS1-C22-H
Plastic Cross/Cold	LWS1-A23-H	LWS1-B23-H	LWS1-C23-H
Plastic Cross/Hot	LWS1-A24-H	LWS1-B24-H	LWS1-C24-H
Wristblade/Cold	LWS1-A25-H	LWS1-B25-H	LWS1-C25-H
Wristblade/Hot	LWS1-A26-H	LWS1-B26-H	LWS1-C26-H

### Straight Nozzle

Handle/Index	Compression Cartridge	Ceramic Cartridge	Control-A-Flow Cartridge
Metal Cross/Cold	LWS1-A11-H	LWS1-B11-H	LWS1-C11-H
Metal Cross/Hot	LWS1-A12-H	LWS1-B12-H	LWS1-C12-H
Plastic Cross/Cold	LWS1-A13-H	LWS1-B13-H	LWS1-C13-H
Plastic Cross/Hot	LWS1-A14-H	LWS1-B14-H	LWS1-C14-H
Wristblade/Cold	LWS1-A15-H	LWS1-B15-H	LWS1-C15-H
Wristblade/Hot	LWS1-A16-H	LWS1-B16-H	LWS1-C16-H

### Straight Nozzle With Aspirator

Handle/Index	Compression Cartridge	Ceramic Cartridge	Control-A-Flow Cartridge
Metal Cross/Cold	LWS1-A31-H	LWS1-B31-H	LWS1-C31-H
Metal Cross/Hot	LWS1-A32-H	LWS1-B32-H	LWS1-C32-H
Plastic Cross/Cold	LWS1-A33-H	LWS1-B33-H	LWS1-C33-H
Plastic Cross/Hot	LWS1-A34-H	<b>LWS1-B34-H</b>	LWS1-C34-H
Wristblade/Cold	LWS1-A35-H	LWS1-B35-H	LWS1-C35-H
Wristblade/Hot	LWS1-A36-H	LWS1-B36-H	LWS1-C36-H

## Deck Mounted, Left-Hand Operation, 5-1/4" Gooseneck Spout

- Solid brass construction
- Polished chrome plated finish
- 1/2" NPSM supply inlet with coupling nut for 3/8" or 1/2" flexible riser



### 2.2 GPM Aerated Outlet

Handle/Index	Compression Cartridge	Ceramic Cartridge	Control-A-Flow Cartridge
Metal Cross/Cold	LWS2-A21-A	LWS2-B21-A	LWS2-C21-A
Metal Cross/Hot	LWS2-A22-A	LWS2-B22-A	LWS2-C22-A
Plastic Cross/Cold	LWS2-A23-A	LWS2-B23-A	LWS2-C23-A
Plastic Cross/Hot	LWS2-A24-A	LWS2-B24-A	LWS2-C24-A
Wristblade/Cold	LWS2-A25-A	LWS2-B25-A	LWS2-C25-A
Wristblade/Hot	LWS2-A26-A	LWS2-B26-A	LWS2-C26-A

### Straight Nozzle

Handle/Index	Compression Cartridge	Ceramic Cartridge	Control-A-Flow Cartridge
Metal Cross/Cold	<b>LWS2-A11-A</b>	LWS2-B11-A	LWS2-C11-A
Metal Cross/Hot	LWS2-A12-A	LWS2-B12-A	LWS2-C12-A
Plastic Cross/Cold	LWS2-A13-A	LWS2-B13-A	LWS2-C13-A
Plastic Cross/Hot	LWS2-A14-A	LWS2-B14-A	LWS2-C14-A
Wristblade/Cold	LWS2-A15-A	LWS2-B15-A	LWS2-C15-A
Wristblade/Hot	LWS2-A16-A	LWS2-B16-A	LWS2-C16-A

### Straight Nozzle With Aspirator

Handle/Index	Compression Cartridge	Ceramic Cartridge	Control-A-Flow Cartridge
Metal Cross/Cold	LWS2-A31-A	LWS2-B31-A	LWS2-C31-A
Metal Cross/Hot	LWS2-A32-A	LWS2-B32-A	LWS2-C32-A
Plastic Cross/Cold	LWS2-A33-A	LWS2-B33-A	LWS2-C33-A
Plastic Cross/Hot	LWS2-A34-A	LWS2-B34-A	LWS2-C34-A
Wristblade/Cold	LWS2-A35-A	LWS2-B35-A	LWS2-C35-A
Wristblade/Hot	LWS2-A36-A	LWS2-B36-A	LWS2-C36-A

## Deck Mounted, Left-Hand Operation, 8" Gooseneck Spout

- Solid brass construction
- Polished chrome plated finish
- 1/2" NPSM supply inlet with coupling nut for 3/8" or 1/2" flexible riser



### 2.2 GPM Aerated Outlet

Handle/Index	Compression Cartridge	Ceramic Cartridge	Control-A-Flow Cartridge
Metal Cross/Cold	LWS2-A21-B	LWS2-B21-B	LWS2-C21-B
Metal Cross/Hot	LWS2-A22-B	LWS2-B22-B	LWS2-C22-B
Plastic Cross/Cold	LWS2-A23-B	LWS2-B23-B	LWS2-C23-B
Plastic Cross/Hot	LWS2-A24-B	LWS2-B24-B	LWS2-C24-B
Wristblade/Cold	<b>LWS2-A25-B</b>	LWS2-B25-B	LWS2-C25-B
Wristblade/Hot	LWS2-A26-B	LWS2-B26-B	LWS2-C26-B

### Straight Nozzle

Handle/Index	Compression Cartridge	Ceramic Cartridge	Control-A-Flow Cartridge
Metal Cross/Cold	LWS2-A11-B	LWS2-B11-B	LWS2-C11-B
Metal Cross/Hot	LWS2-A12-B	LWS2-B12-B	LWS2-C12-B
Plastic Cross/Cold	LWS2-A13-B	LWS2-B13-B	LWS2-C13-B
Plastic Cross/Hot	LWS2-A14-B	LWS2-B14-B	LWS2-C14-B
Wristblade/Cold	LWS2-A15-B	LWS2-B15-B	LWS2-C15-B
Wristblade/Hot	LWS2-A16-B	LWS2-B16-B	LWS2-C16-B

### Straight Nozzle With Aspirator

Handle/Index	Compression Cartridge	Ceramic Cartridge	Control-A-Flow Cartridge
Metal Cross/Cold	LWS2-A31-B	LWS2-B31-B	LWS2-C31-B
Metal Cross/Hot	LWS2-A32-B	LWS2-B32-B	LWS2-C32-B
Plastic Cross/Cold	LWS2-A33-B	LWS2-B33-B	LWS2-C33-B
Plastic Cross/Hot	LWS2-A34-B	LWS2-B34-B	LWS2-C34-B
Wristblade/Cold	LWS2-A35-B	LWS2-B35-B	LWS2-C35-B
Wristblade/Hot	LWS2-A36-B	LWS2-B36-B	LWS2-C36-B

## Deck Mounted, Left-Hand Operation, 5-1/4" Gooseneck Spout with Vacuum Breaker

- Solid brass construction
- Polished chrome plated finish
- 1/2" NPSM supply inlet with coupling nut for 3/8" or 1/2" flexible riser



### 2.2 GPM Aerated Outlet

Handle/Index	Compression Cartridge	Ceramic Cartridge	Control-A-Flow Cartridge
Metal Cross/Cold	LWS2-A21-E	LWS2-B21-E	LWS2-C21-E
Metal Cross/Hot	LWS2-A22-E	LWS2-B22-E	LWS2-C22-E
Plastic Cross/Cold	LWS2-A23-E	LWS2-B23-E	<b>LWS2-C23-E</b>
Plastic Cross/Hot	LWS2-A24-E	LWS2-B24-E	LWS2-C24-E
Wristblade/Cold	LWS2-A25-E	LWS2-B25-E	LWS2-C25-E
Wristblade/Hot	LWS2-A26-E	LWS2-B26-E	LWS2-C26-E

### Straight Nozzle

Handle/Index	Compression Cartridge	Ceramic Cartridge	Control-A-Flow Cartridge
Metal Cross/Cold	LWS2-A11-E	LWS2-B11-E	LWS2-C11-E
Metal Cross/Hot	LWS2-A12-E	LWS2-B12-E	LWS2-C12-E
Plastic Cross/Cold	LWS2-A13-E	LWS2-B13-E	LWS2-C13-E
Plastic Cross/Hot	LWS2-A14-E	LWS2-B14-E	LWS2-C14-E
Wristblade/Cold	LWS2-A15-E	LWS2-B15-E	LWS2-C15-E
Wristblade/Hot	LWS2-A16-E	LWS2-B16-E	LWS2-C16-E

### Straight Nozzle With Aspirator

Handle/Index	Compression Cartridge	Ceramic Cartridge	Control-A-Flow Cartridge
Metal Cross/Cold	LWS2-A31-E	LWS2-B31-E	LWS2-C31-E
Metal Cross/Hot	LWS2-A32-E	LWS2-B32-E	LWS2-C32-E
Plastic Cross/Cold	LWS2-A33-E	LWS2-B33-E	LWS2-C33-E
Plastic Cross/Hot	LWS2-A34-E	LWS2-B34-E	LWS2-C34-E
Wristblade/Cold	LWS2-A35-E	LWS2-B35-E	LWS2-C35-E
Wristblade/Hot	LWS2-A36-E	LWS2-B36-E	LWS2-C36-E

## Deck Mounted, Left-Hand Operation, 8" Gooseneck Spout with Vacuum Breaker

- Solid brass construction
- Polished chrome plated finish
- 1/2" NPSM supply inlet with coupling nut for 3/8" or 1/2" flexible riser



### 2.2 GPM Aerated Outlet

Handle/Index	Compression Cartridge	Ceramic Cartridge	Control-A-Flow Cartridge
Metal Cross/Cold	LWS2-A21-F	LWS2-B21-F	LWS2-C21-F
Metal Cross/Hot	LWS2-A22-F	LWS2-B22-F	LWS2-C22-F
Plastic Cross/Cold	LWS2-A23-F	LWS2-B23-F	LWS2-C23-F
Plastic Cross/Hot	LWS2-A24-F	LWS2-B24-F	LWS2-C24-F
Wristblade/Cold	LWS2-A25-F	LWS2-B25-F	LWS2-C25-F
Wristblade/Hot	LWS2-A26-F	LWS2-B26-F	LWS2-C26-F

### Straight Nozzle

Handle/Index	Compression Cartridge	Ceramic Cartridge	Control-A-Flow Cartridge
Metal Cross/Cold	LWS2-A11-F	LWS2-B11-F	LWS2-C11-F
Metal Cross/Hot	LWS2-A12-F	LWS2-B12-F	LWS2-C12-F
Plastic Cross/Cold	LWS2-A13-F	LWS2-B13-F	LWS2-C13-F
Plastic Cross/Hot	LWS2-A14-F	<b>LWS2-B14-F</b>	LWS2-C14-F
Wristblade/Cold	LWS2-A15-F	LWS2-B15-F	LWS2-C15-F
Wristblade/Hot	LWS2-A16-F	LWS2-B16-F	LWS2-C16-F

### Straight Nozzle With Aspirator

Handle/Index	Compression Cartridge	Ceramic Cartridge	Control-A-Flow Cartridge
Metal Cross/Cold	LWS2-A31-F	LWS2-B31-F	LWS2-C31-F
Metal Cross/Hot	LWS2-A32-F	LWS2-B32-F	LWS2-C32-F
Plastic Cross/Cold	LWS2-A33-F	LWS2-B33-F	LWS2-C33-F
Plastic Cross/Hot	LWS2-A34-F	LWS2-B34-F	LWS2-C34-F
Wristblade/Cold	LWS2-A35-F	LWS2-B35-F	LWS2-C35-F
Wristblade/Hot	LWS2-A36-F	LWS2-B36-F	LWS2-C36-F

## Deck Mounted, Left-Hand Operation, 5-1/4" Rigid Spout with Vacuum Breaker

- Solid brass construction
- Polished chrome plated finish
- 1/2" NPSM supply inlet with coupling nut for 3/8" or 1/2" flexible riser



### 2.2 GPM Aerated Outlet

Handle/Index	Compression Cartridge	Ceramic Cartridge	Control-A-Flow Cartridge
Metal Cross/Cold	LWS2-A21-G	LWS2-B21-G	LWS2-C21-G
Metal Cross/Hot	LWS2-A22-G	LWS2-B22-G	LWS2-C22-G
Plastic Cross/Cold	LWS2-A23-G	LWS2-B23-G	LWS2-C23-G
Plastic Cross/Hot	LWS2-A24-G	LWS2-B24-G	LWS2-C24-G
Wristblade/Cold	LWS2-A25-G	LWS2-B25-G	LWS2-C25-G
Wristblade/Hot	LWS2-A26-G	LWS2-B26-G	LWS2-C26-G

### Straight Nozzle

Handle/Index	Compression Cartridge	Ceramic Cartridge	Control-A-Flow Cartridge
Metal Cross/Cold	LWS2-A11-G	LWS2-B11-G	LWS2-C11-G
Metal Cross/Hot	LWS2-A12-G	LWS2-B12-G	LWS2-C12-G
Plastic Cross/Cold	LWS2-A13-G	LWS2-B13-G	LWS2-C13-G
Plastic Cross/Hot	LWS2-A14-G	LWS2-B14-G	LWS2-C14-G
Wristblade/Cold	LWS2-A15-G	LWS2-B15-G	<b>LWS2-C15-G</b>
Wristblade/Hot	LWS2-A16-G	LWS2-B16-G	LWS2-C16-G

### Straight Nozzle With Aspirator

Handle/Index	Compression Cartridge	Ceramic Cartridge	Control-A-Flow Cartridge
Metal Cross/Cold	LWS2-A31-G	LWS2-B31-G	LWS2-C31-G
Metal Cross/Hot	LWS2-A32-G	LWS2-B32-G	LWS2-C32-G
Plastic Cross/Cold	LWS2-A33-G	LWS2-B33-G	LWS2-C33-G
Plastic Cross/Hot	LWS2-A34-G	LWS2-B34-G	LWS2-C34-G
Wristblade/Cold	LWS2-A35-G	LWS2-B35-G	LWS2-C35-G
Wristblade/Hot	LWS2-A36-G	LWS2-B36-G	LWS2-C36-G

## Deck Mounted, Left-Hand Operation, 8" Rigid Spout with Vacuum Breaker

- Solid brass construction
- Polished chrome plated finish
- 1/2" NPSM supply inlet with coupling nut for 3/8" or 1/2" flexible riser



### 2.2 GPM Aerated Outlet

Handle/Index	Compression Cartridge	Ceramic Cartridge	Control-A-Flow Cartridge
Metal Cross/Cold	LWS2-A21-H	LWS2-B21-H	LWS2-C21-H
Metal Cross/Hot	LWS2-A22-H	LWS2-B22-H	<b>LWS2-C22-H</b>
Plastic Cross/Cold	LWS2-A23-H	LWS2-B23-H	LWS2-C23-H
Plastic Cross/Hot	LWS2-A24-H	LWS2-B24-H	LWS2-C24-H
Wristblade/Cold	LWS2-A25-H	LWS2-B25-H	LWS2-C25-H
Wristblade/Hot	LWS2-A26-H	LWS2-B26-H	LWS2-C26-H

### Straight Nozzle

Handle/Index	Compression Cartridge	Ceramic Cartridge	Control-A-Flow Cartridge
Metal Cross/Cold	LWS2-A11-H	LWS2-B11-H	LWS2-C11-H
Metal Cross/Hot	LWS2-A12-H	LWS2-B12-H	LWS2-C12-H
Plastic Cross/Cold	LWS2-A13-H	LWS2-B13-H	LWS2-C13-H
Plastic Cross/Hot	LWS2-A14-H	LWS2-B14-H	LWS2-C14-H
Wristblade/Cold	LWS2-A15-H	LWS2-B15-H	LWS2-C15-H
Wristblade/Hot	LWS2-A16-H	LWS2-B16-H	LWS2-C16-H

### Straight Nozzle With Aspirator

Handle/Index	Compression Cartridge	Ceramic Cartridge	Control-A-Flow Cartridge
Metal Cross/Cold	LWS2-A31-H	LWS2-B31-H	LWS2-C31-H
Metal Cross/Hot	LWS2-A32-H	LWS2-B32-H	LWS2-C32-H
Plastic Cross/Cold	LWS2-A33-H	LWS2-B33-H	LWS2-C33-H
Plastic Cross/Hot	LWS2-A34-H	LWS2-B34-H	LWS2-C34-H
Wristblade/Cold	LWS2-A35-H	LWS2-B35-H	LWS2-C35-H
Wristblade/Hot	LWS2-A36-H	LWS2-B36-H	LWS2-C36-H

## Deck Mounted, Back-Mounted Handle, 5-1/4" Gooseneck Spout

- Solid brass construction
- Polished chrome plated finish
- 1/2" NPSM supply inlet with coupling nut for 3/8" or 1/2" flexible riser



### 2.2 GPM Aerated Outlet

Handle/Index	Compression Cartridge	Ceramic Cartridge	Control-A-Flow Cartridge
Metal Cross/Cold	LWS3-A21-A	LWS3-B21-A	<b>LWS3-C21-A</b>
Metal Cross/Hot	LWS3-A22-A	LWS3-B22-A	LWS3-C22-A
Plastic Cross/Cold	LWS3-A23-A	LWS3-B23-A	LWS3-C23-A
Plastic Cross/Hot	LWS3-A24-A	LWS3-B24-A	LWS3-C24-A
Wristblade/Cold	LWS3-A25-A	LWS3-B25-A	LWS3-C25-A
Wristblade/Hot	LWS3-A26-A	LWS3-B26-A	LWS3-C26-A

### Straight Nozzle

Handle/Index	Compression Cartridge	Ceramic Cartridge	Control-A-Flow Cartridge
Metal Cross/Cold	LWS3-A11-A	LWS3-B11-A	LWS3-C11-A
Metal Cross/Hot	LWS3-A12-A	LWS3-B12-A	LWS3-C12-A
Plastic Cross/Cold	LWS3-A13-A	LWS3-B13-A	LWS3-C13-A
Plastic Cross/Hot	LWS3-A14-A	LWS3-B14-A	LWS3-C14-A
Wristblade/Cold	LWS3-A15-A	LWS3-B15-A	LWS3-C15-A
Wristblade/Hot	LWS3-A16-A	LWS3-B16-A	LWS3-C16-A

### Straight Nozzle With Aspirator

Handle/Index	Compression Cartridge	Ceramic Cartridge	Control-A-Flow Cartridge
Metal Cross/Cold	LWS3-A31-A	LWS3-B31-A	LWS3-C31-A
Metal Cross/Hot	LWS3-A32-A	LWS3-B32-A	LWS3-C32-A
Plastic Cross/Cold	LWS3-A33-A	LWS3-B33-A	LWS3-C33-A
Plastic Cross/Hot	LWS3-A34-A	LWS3-B34-A	LWS3-C34-A
Wristblade/Cold	LWS3-A35-A	LWS3-B35-A	LWS3-C35-A
Wristblade/Hot	LWS3-A36-A	LWS3-B36-A	LWS3-C36-A

## Deck Mounted, Back-Mounted Handle, 8" Gooseneck Spout

- Solid brass construction
- Polished chrome plated finish
- 1/2" NPSM supply inlet with coupling nut for 3/8" or 1/2" flexible riser



### 2.2 GPM Aerated Outlet

Handle/Index	Compression Cartridge	Ceramic Cartridge	Control-A-Flow Cartridge
Metal Cross/Cold	LWS3-A21-B	LWS3-B21-B	LWS3-C21-B
Metal Cross/Hot	LWS3-A22-B	LWS3-B22-B	LWS3-C22-B
Plastic Cross/Cold	LWS3-A23-B	LWS3-B23-B	LWS3-C23-B
Plastic Cross/Hot	LWS3-A24-B	LWS3-B24-B	LWS3-C24-B
Wristblade/Cold	LWS3-A25-B	LWS3-B25-B	LWS3-C25-B
Wristblade/Hot	LWS3-A26-B	LWS3-B26-B	LWS3-C26-B

### Straight Nozzle

Handle/Index	Compression Cartridge	Ceramic Cartridge	Control-A-Flow Cartridge
Metal Cross/Cold	LWS3-A11-B	LWS3-B11-B	LWS3-C11-B
Metal Cross/Hot	LWS3-A12-B	LWS3-B12-B	<b>LWS3-C12-B</b>
Plastic Cross/Cold	LWS3-A13-B	LWS3-B13-B	LWS3-C13-B
Plastic Cross/Hot	LWS3-A14-B	LWS3-B14-B	LWS3-C14-B
Wristblade/Cold	LWS3-A15-B	LWS3-B15-B	LWS3-C15-B
Wristblade/Hot	LWS3-A16-B	LWS3-B16-B	LWS3-C16-B

### Straight Nozzle With Aspirator

Handle/Index	Compression Cartridge	Ceramic Cartridge	Control-A-Flow Cartridge
Metal Cross/Cold	LWS3-A31-B	LWS3-B31-B	LWS3-C31-B
Metal Cross/Hot	LWS3-A32-B	LWS3-B32-B	LWS3-C32-B
Plastic Cross/Cold	LWS3-A33-B	LWS3-B33-B	LWS3-C33-B
Plastic Cross/Hot	LWS3-A34-B	LWS3-B34-B	LWS3-C34-B
Wristblade/Cold	LWS3-A35-B	LWS3-B35-B	LWS3-C35-B
Wristblade/Hot	LWS3-A36-B	LWS3-B36-B	LWS3-C36-B

## Deck Mounted, Back-Mounted Handle, 5-1/4" Gooseneck Spout with Vacuum Breaker

- Solid brass construction
- Polished chrome plated finish
- 1/2" NPSM supply inlet with coupling nut for 3/8" or 1/2" flexible riser



### 2.2 GPM Aerated Outlet

Handle/Index	Compression Cartridge	Ceramic Cartridge	Control-A-Flow Cartridge
Metal Cross/Cold	LWS3-A21-E	LWS3-B21-E	LWS3-C21-E
Metal Cross/Hot	LWS3-A22-E	LWS3-B22-E	LWS3-C22-E
Plastic Cross/Cold	LWS3-A23-E	LWS3-B23-E	LWS3-C23-E
Plastic Cross/Hot	LWS3-A24-E	LWS3-B24-E	LWS3-C24-E
Wristblade/Cold	LWS3-A25-E	LWS3-B25-E	LWS3-C25-E
Wristblade/Hot	LWS3-A26-E	LWS3-B26-E	LWS3-C26-E

### Straight Nozzle

Handle/Index	Compression Cartridge	Ceramic Cartridge	Control-A-Flow Cartridge
Metal Cross/Cold	LWS3-A11-E	LWS3-B11-E	LWS3-C11-E
Metal Cross/Hot	LWS3-A12-E	LWS3-B12-E	LWS3-C12-E
Plastic Cross/Cold	<b>LWS3-A13-E</b>	LWS3-B13-E	LWS3-C13-E
Plastic Cross/Hot	LWS3-A14-E	LWS3-B14-E	LWS3-C14-E
Wristblade/Cold	LWS3-A15-E	LWS3-B15-E	LWS3-C15-E
Wristblade/Hot	LWS3-A16-E	LWS3-B16-E	LWS3-C16-E

### Straight Nozzle With Aspirator

Handle/Index	Compression Cartridge	Ceramic Cartridge	Control-A-Flow Cartridge
Metal Cross/Cold	LWS3-A31-E	LWS3-B31-E	LWS3-C31-E
Metal Cross/Hot	LWS3-A32-E	LWS3-B32-E	LWS3-C32-E
Plastic Cross/Cold	LWS3-A33-E	LWS3-B33-E	LWS3-C33-E
Plastic Cross/Hot	LWS3-A34-E	LWS3-B34-E	LWS3-C34-E
Wristblade/Cold	LWS3-A35-E	LWS3-B35-E	LWS3-C35-E
Wristblade/Hot	LWS3-A36-E	LWS3-B36-E	LWS3-C36-E

## Deck Mounted, Back-Mounted Handle, 8" Gooseneck Spout with Vacuum Breaker

- Solid brass construction
- Polished chrome plated finish
- 1/2" NPSM supply inlet with coupling nut for 3/8" or 1/2" flexible riser



### 2.2 GPM Aerated Outlet

Handle/Index	Compression Cartridge	Ceramic Cartridge	Control-A-Flow Cartridge
Metal Cross/Cold	LWS3-A21-F	LWS3-B21-F	LWS3-C21-F
Metal Cross/Hot	LWS3-A22-F	LWS3-B22-F	LWS3-C22-F
Plastic Cross/Cold	LWS3-A23-F	LWS3-B23-F	LWS3-C23-F
Plastic Cross/Hot	LWS3-A24-F	LWS3-B24-F	LWS3-C24-F
Wristblade/Cold	LWS3-A25-F	LWS3-B25-F	LWS3-C25-F
Wristblade/Hot	LWS3-A26-F	LWS3-B26-F	LWS3-C26-F

### Straight Nozzle

Handle/Index	Compression Cartridge	Ceramic Cartridge	Control-A-Flow Cartridge
Metal Cross/Cold	LWS3-A11-F	LWS3-B11-F	LWS3-C11-F
Metal Cross/Hot	LWS3-A12-F	LWS3-B12-F	LWS3-C12-F
Plastic Cross/Cold	LWS3-A13-F	LWS3-B13-F	LWS3-C13-F
Plastic Cross/Hot	LWS3-A14-F	LWS3-B14-F	LWS3-C14-F
Wristblade/Cold	LWS3-A15-F	LWS3-B15-F	LWS3-C15-F
Wristblade/Hot	LWS3-A16-F	LWS3-B16-F	LWS3-C16-F

### Straight Nozzle With Aspirator

Handle/Index	Compression Cartridge	Ceramic Cartridge	Control-A-Flow Cartridge
Metal Cross/Cold	LWS3-A31-F	LWS3-B31-F	LWS3-C31-F
Metal Cross/Hot	LWS3-A32-F	LWS3-B32-F	LWS3-C32-F
Plastic Cross/Cold	LWS3-A33-F	LWS3-B33-F	LWS3-C33-F
Plastic Cross/Hot	<b>LWS3-A34-F</b>	LWS3-B34-F	LWS3-C34-F
Wristblade/Cold	LWS3-A35-F	LWS3-B35-F	LWS3-C35-F
Wristblade/Hot	LWS3-A36-F	LWS3-B36-F	LWS3-C36-F



## Deck Mounted, Back-Mounted Handle, 5-1/4" Rigid Spout with Vacuum Breaker

- Solid brass construction
- Polished chrome plated finish
- 1/2" NPSM supply inlet with coupling nut for 3/8" or 1/2" flexible riser



### 2.2 GPM Aerated Outlet

Handle/Index	Compression Cartridge	Ceramic Cartridge	Control-A-Flow Cartridge
Metal Cross/Cold	LWS3-A21-G	LWS3-B21-G	LWS3-C21-G
Metal Cross/Hot	LWS3-A22-G	LWS3-B22-G	LWS3-C22-G
Plastic Cross/Cold	LWS3-A23-G	LWS3-B23-G	LWS3-C23-G
Plastic Cross/Hot	LWS3-A24-G	LWS3-B24-G	LWS3-C24-G
Wristblade/Cold	LWS3-A25-G	<b>LWS3-B25-G</b>	LWS3-C25-G
Wristblade/Hot	LWS3-A26-G	LWS3-B26-G	LWS3-C26-G

### Straight Nozzle

Handle/Index	Compression Cartridge	Ceramic Cartridge	Control-A-Flow Cartridge
Metal Cross/Cold	LWS3-A11-G	LWS3-B11-G	LWS3-C11-G
Metal Cross/Hot	LWS3-A12-G	LWS3-B12-G	LWS3-C12-G
Plastic Cross/Cold	LWS3-A13-G	LWS3-B13-G	LWS3-C13-G
Plastic Cross/Hot	LWS3-A14-G	LWS3-B14-G	LWS3-C14-G
Wristblade/Cold	LWS3-A15-G	LWS3-B15-G	LWS3-C15-G
Wristblade/Hot	LWS3-A16-G	LWS3-B16-G	LWS3-C16-G

### Straight Nozzle With Aspirator

Handle/Index	Compression Cartridge	Ceramic Cartridge	Control-A-Flow Cartridge
Metal Cross/Cold	LWS3-A31-G	LWS3-B31-G	LWS3-C31-G
Metal Cross/Hot	LWS3-A32-G	LWS3-B32-G	LWS3-C32-G
Plastic Cross/Cold	LWS3-A33-G	LWS3-B33-G	LWS3-C33-G
Plastic Cross/Hot	LWS3-A34-G	LWS3-B34-G	LWS3-C34-G
Wristblade/Cold	LWS3-A35-G	LWS3-B35-G	LWS3-C35-G
Wristblade/Hot	LWS3-A36-G	LWS3-B36-G	LWS3-C36-G

## Deck Mounted, Back-Mounted Handle, 8" Rigid Spout with Vacuum Breaker

- Solid brass construction
- Polished chrome plated finish
- 1/2" NPSM supply inlet with coupling nut for 3/8" or 1/2" flexible riser



### 2.2 GPM Aerated Outlet

Handle/Index	Compression Cartridge	Ceramic Cartridge	Control-A-Flow Cartridge
Metal Cross/Cold	LWS3-A21-H	LWS3-B21-H	LWS3-C21-H
Metal Cross/Hot	LWS3-A22-H	LWS3-B22-H	LWS3-C22-H
Plastic Cross/Cold	LWS3-A23-H	LWS3-B23-H	LWS3-C23-H
Plastic Cross/Hot	<b>LWS3-A24-H</b>	LWS3-B24-H	LWS3-C24-H
Wristblade/Cold	LWS3-A25-H	LWS3-B25-H	LWS3-C25-H
Wristblade/Hot	LWS3-A26-H	LWS3-B26-H	LWS3-C26-H

### Straight Nozzle

Handle/Index	Compression Cartridge	Ceramic Cartridge	Control-A-Flow Cartridge
Metal Cross/Cold	LWS3-A11-H	LWS3-B11-H	LWS3-C11-H
Metal Cross/Hot	LWS3-A12-H	LWS3-B12-H	LWS3-C12-H
Plastic Cross/Cold	LWS3-A13-H	LWS3-B13-H	LWS3-C13-H
Plastic Cross/Hot	LWS3-A14-H	LWS3-B14-H	LWS3-C14-H
Wristblade/Cold	LWS3-A15-H	LWS3-B15-H	LWS3-C15-H
Wristblade/Hot	LWS3-A16-H	LWS3-B16-H	LWS3-C16-H

### Straight Nozzle With Aspirator

Handle/Index	Compression Cartridge	Ceramic Cartridge	Control-A-Flow Cartridge
Metal Cross/Cold	LWS3-A31-H	LWS3-B31-H	LWS3-C31-H
Metal Cross/Hot	LWS3-A32-H	LWS3-B32-H	LWS3-C32-H
Plastic Cross/Cold	LWS3-A33-H	LWS3-B33-H	LWS3-C33-H
Plastic Cross/Hot	LWS3-A34-H	LWS3-B34-H	LWS3-C34-H
Wristblade/Cold	LWS3-A35-H	LWS3-B35-H	LWS3-C35-H
Wristblade/Hot	LWS3-A36-H	LWS3-B36-H	LWS3-C36-H

## Wall Mounted, 5-1/4" Gooseneck Spout, Less Shank

- Solid brass construction
- Polished chrome plated finish
- 1/2" NPT female thread inlet with integral flange



### 2.2 GPM Aerated Outlet

Handle/Index	Compression Cartridge	Ceramic Cartridge	Control-A-Flow Cartridge
Metal Cross/Cold	LWS4-A21-A	LWS4-B21-A	LWS4-C21-A
Metal Cross/Hot	LWS4-A22-A	LWS4-B22-A	LWS4-C22-A
Plastic Cross/Cold	LWS4-A23-A	LWS4-B23-A	LWS4-C23-A
Plastic Cross/Hot	LWS4-A24-A	LWS4-B24-A	LWS4-C24-A
Wristblade/Cold	LWS4-A25-A	LWS4-B25-A	LWS4-C25-A
Wristblade/Hot	LWS4-A26-A	LWS4-B26-A	LWS4-C26-A

### Straight Nozzle

Handle/Index	Compression Cartridge	Ceramic Cartridge	Control-A-Flow Cartridge
Metal Cross/Cold	LWS4-A11-A	<b>LWS4-B11-A</b>	LWS4-C11-A
Metal Cross/Hot	LWS4-A12-A	LWS4-B12-A	LWS4-C12-A
Plastic Cross/Cold	LWS4-A13-A	LWS4-B13-A	LWS4-C13-A
Plastic Cross/Hot	LWS4-A14-A	LWS4-B14-A	LWS4-C14-A
Wristblade/Cold	LWS4-A15-A	LWS4-B15-A	LWS4-C15-A
Wristblade/Hot	LWS4-A16-A	LWS4-B16-A	LWS4-C16-A

### Straight Nozzle With Aspirator

Handle/Index	Compression Cartridge	Ceramic Cartridge	Control-A-Flow Cartridge
Metal Cross/Cold	LWS4-A31-A	LWS4-B31-A	LWS4-C31-A
Metal Cross/Hot	LWS4-A32-A	LWS4-B32-A	LWS4-C32-A
Plastic Cross/Cold	LWS4-A33-A	LWS4-B33-A	LWS4-C33-A
Plastic Cross/Hot	LWS4-A34-A	LWS4-B34-A	LWS4-C34-A
Wristblade/Cold	LWS4-A35-A	LWS4-B35-A	LWS4-C35-A
Wristblade/Hot	LWS4-A36-A	LWS4-B36-A	LWS4-C36-A

## Wall Mounted, 8" Gooseneck Spout, Less Shank

- Solid brass construction
- Polished chrome plated finish
- 1/2" NPT female thread inlet with integral flange



### 2.2 GPM Aerated Outlet

Handle/Index	Compression Cartridge	Ceramic Cartridge	Control-A-Flow Cartridge
Metal Cross/Cold	LWS4-A21-B	LWS4-B21-B	LWS4-C21-B
Metal Cross/Hot	LWS4-A22-B	LWS4-B22-B	LWS4-C22-B
Plastic Cross/Cold	LWS4-A23-B	LWS4-B23-B	LWS4-C23-B
Plastic Cross/Hot	LWS4-A24-B	LWS4-B24-B	LWS4-C24-B
Wristblade/Cold	LWS4-A25-B	LWS4-B25-B	LWS4-C25-B
Wristblade/Hot	<b>LWS4-A26-B</b>	LWS4-B26-B	LWS4-C26-B

### Straight Nozzle

Handle/Index	Compression Cartridge	Ceramic Cartridge	Control-A-Flow Cartridge
Metal Cross/Cold	LWS4-A11-B	LWS4-B11-B	LWS4-C11-B
Metal Cross/Hot	LWS4-A12-B	LWS4-B12-B	LWS4-C12-B
Plastic Cross/Cold	LWS4-A13-B	LWS4-B13-B	LWS4-C13-B
Plastic Cross/Hot	LWS4-A14-B	LWS4-B14-B	LWS4-C14-B
Wristblade/Cold	LWS4-A15-B	LWS4-B15-B	LWS4-C15-B
Wristblade/Hot	LWS4-A16-B	LWS4-B16-B	LWS4-C16-B

### Straight Nozzle With Aspirator

Handle/Index	Compression Cartridge	Ceramic Cartridge	Control-A-Flow Cartridge
Metal Cross/Cold	LWS4-A31-B	LWS4-B31-B	LWS4-C31-B
Metal Cross/Hot	LWS4-A32-B	LWS4-B32-B	LWS4-C32-B
Plastic Cross/Cold	LWS4-A33-B	LWS4-B33-B	LWS4-C33-B
Plastic Cross/Hot	LWS4-A34-B	LWS4-B34-B	LWS4-C34-B
Wristblade/Cold	LWS4-A35-B	LWS4-B35-B	LWS4-C35-B
Wristblade/Hot	LWS4-A36-B	LWS4-B36-B	LWS4-C36-B

## Wall Mounted, 5-1/4" Gooseneck Spout with Vacuum Breaker, Less Shank

- Solid brass construction
- Polished chrome plated finish
- 1/2" NPT female thread inlet with integral flange



### 2.2 GPM Aerated Outlet

Handle/Index	Compression Cartridge	Ceramic Cartridge	Control-A-Flow Cartridge
Metal Cross/Cold	LWS4-A21-E	LWS4-B21-E	LWS4-C21-E
Metal Cross/Hot	LWS4-A22-E	LWS4-B22-E	LWS4-C22-E
Plastic Cross/Cold	LWS4-A23-E	LWS4-B23-E	LWS4-C23-E
Plastic Cross/Hot	LWS4-A24-E	LWS4-B24-E	LWS4-C24-E
Wristblade/Cold	LWS4-A25-E	LWS4-B25-E	LWS4-C25-E
Wristblade/Hot	LWS4-A26-E	LWS4-B26-E	LWS4-C26-E

### Straight Nozzle

Handle/Index	Compression Cartridge	Ceramic Cartridge	Control-A-Flow Cartridge
Metal Cross/Cold	LWS4-A11-E	LWS4-B11-E	LWS4-C11-E
Metal Cross/Hot	LWS4-A12-E	LWS4-B12-E	LWS4-C12-E
Plastic Cross/Cold	LWS4-A13-E	LWS4-B13-E	LWS4-C13-E
Plastic Cross/Hot	LWS4-A14-E	LWS4-B14-E	LWS4-C14-E
Wristblade/Cold	LWS4-A15-E	LWS4-B15-E	LWS4-C15-E
Wristblade/Hot	LWS4-A16-E	LWS4-B16-E	LWS4-C16-E

### Straight Nozzle With Aspirator

Handle/Index	Compression Cartridge	Ceramic Cartridge	Control-A-Flow Cartridge
Metal Cross/Cold	LWS4-A31-E	LWS4-B31-E	LWS4-C31-E
Metal Cross/Hot	LWS4-A32-E	LWS4-B32-E	LWS4-C32-E
Plastic Cross/Cold	<b>LWS4-A33-E</b>	LWS4-B33-E	LWS4-C33-E
Plastic Cross/Hot	LWS4-A34-E	LWS4-B34-E	LWS4-C34-E
Wristblade/Cold	LWS4-A35-E	LWS4-B35-E	LWS4-C35-E
Wristblade/Hot	LWS4-A36-E	LWS4-B36-E	LWS4-C36-E

## Wall Mounted, 8" Gooseneck Spout with Vacuum Breaker, Less Shank

- Solid brass construction
- Polished chrome plated finish
- 1/2" NPT female thread inlet with integral flange



### 2.2 GPM Aerated Outlet

Handle/Index	Compression Cartridge	Ceramic Cartridge	Control-A-Flow Cartridge
Metal Cross/Cold	LWS4-A21-F	<b>LWS4-B21-F</b>	LWS4-C21-F
Metal Cross/Hot	LWS4-A22-F	LWS4-B22-F	LWS4-C22-F
Plastic Cross/Cold	LWS4-A23-F	LWS4-B23-F	LWS4-C23-F
Plastic Cross/Hot	LWS4-A24-F	LWS4-B24-F	LWS4-C24-F
Wristblade/Cold	LWS4-A25-F	LWS4-B25-F	LWS4-C25-F
Wristblade/Hot	LWS4-A26-F	LWS4-B26-F	LWS4-C26-F

### Straight Nozzle

Handle/Index	Compression Cartridge	Ceramic Cartridge	Control-A-Flow Cartridge
Metal Cross/Cold	LWS4-A11-F	LWS4-B11-F	LWS4-C11-F
Metal Cross/Hot	LWS4-A12-F	LWS4-B12-F	LWS4-C12-F
Plastic Cross/Cold	LWS4-A13-F	LWS4-B13-F	LWS4-C13-F
Plastic Cross/Hot	LWS4-A14-F	LWS4-B14-F	LWS4-C14-F
Wristblade/Cold	LWS4-A15-F	LWS4-B15-F	LWS4-C15-F
Wristblade/Hot	LWS4-A16-F	LWS4-B16-F	LWS4-C16-F

### Straight Nozzle With Aspirator

Handle/Index	Compression Cartridge	Ceramic Cartridge	Control-A-Flow Cartridge
Metal Cross/Cold	LWS4-A31-F	LWS4-B31-F	LWS4-C31-F
Metal Cross/Hot	LWS4-A32-F	LWS4-B32-F	LWS4-C32-F
Plastic Cross/Cold	LWS4-A33-F	LWS4-B33-F	LWS4-C33-F
Plastic Cross/Hot	LWS4-A34-F	LWS4-B34-F	LWS4-C34-F
Wristblade/Cold	LWS4-A35-F	LWS4-B35-F	LWS4-C35-F
Wristblade/Hot	LWS4-A36-F	LWS4-B36-F	LWS4-C36-F

## Wall Mounted, 5-1/4" Rigid Spout with Vacuum Breaker, Less Shank

- Solid brass construction
- Polished chrome plated finish
- 1/2" NPT female thread inlet with integral flange



### 2.2 GPM Aerated Outlet

Handle/Index	Compression Cartridge	Ceramic Cartridge	Control-A-Flow Cartridge
Metal Cross/Cold	LWS4-A21-G	LWS4-B21-G	LWS4-C21-G
Metal Cross/Hot	LWS4-A22-G	LWS4-B22-G	LWS4-C22-G
Plastic Cross/Cold	LWS4-A23-G	LWS4-B23-G	LWS4-C23-G
Plastic Cross/Hot	LWS4-A24-G	LWS4-B24-G	LWS4-C24-G
Wristblade/Cold	LWS4-A25-G	LWS4-B25-G	<b>LWS4-C25-G</b>
Wristblade/Hot	LWS4-A26-G	LWS4-B26-G	LWS4-C26-G

### Straight Nozzle

Handle/Index	Compression Cartridge	Ceramic Cartridge	Control-A-Flow Cartridge
Metal Cross/Cold	LWS4-A11-G	LWS4-B11-G	LWS4-C11-G
Metal Cross/Hot	LWS4-A12-G	LWS4-B12-G	LWS4-C12-G
Plastic Cross/Cold	LWS4-A13-G	LWS4-B13-G	LWS4-C13-G
Plastic Cross/Hot	LWS4-A14-G	LWS4-B14-G	LWS4-C14-G
Wristblade/Cold	LWS4-A15-G	LWS4-B15-G	LWS4-C15-G
Wristblade/Hot	LWS4-A16-G	LWS4-B16-G	LWS4-C16-G

### Straight Nozzle With Aspirator

Handle/Index	Compression Cartridge	Ceramic Cartridge	Control-A-Flow Cartridge
Metal Cross/Cold	LWS4-A31-G	LWS4-B31-G	LWS4-C31-G
Metal Cross/Hot	LWS4-A32-G	LWS4-B32-G	LWS4-C32-G
Plastic Cross/Cold	LWS4-A33-G	LWS4-B33-G	LWS4-C33-G
Plastic Cross/Hot	LWS4-A34-G	LWS4-B34-G	LWS4-C34-G
Wristblade/Cold	LWS4-A35-G	LWS4-B35-G	LWS4-C35-G
Wristblade/Hot	LWS4-A36-G	LWS4-B36-G	LWS4-C36-G

## Wall Mounted, 8" Rigid Spout with Vacuum Breaker, Less Shank

- Solid brass construction
- Polished chrome plated finish
- 1/2" NPT female thread inlet with integral flange



### 2.2 GPM Aerated Outlet

Handle/Index	Compression Cartridge	Ceramic Cartridge	Control-A-Flow Cartridge
Metal Cross/Cold	LWS4-A21-H	LWS4-B21-H	LWS4-C21-H
Metal Cross/Hot	LWS4-A22-H	LWS4-B22-H	LWS4-C22-H
Plastic Cross/Cold	LWS4-A23-H	LWS4-B23-H	LWS4-C23-H
Plastic Cross/Hot	LWS4-A24-H	LWS4-B24-H	LWS4-C24-H
Wristblade/Cold	LWS4-A25-H	LWS4-B25-H	LWS4-C25-H
Wristblade/Hot	LWS4-A26-H	LWS4-B26-H	LWS4-C26-H

### Straight Nozzle

Handle/Index	Compression Cartridge	Ceramic Cartridge	Control-A-Flow Cartridge
Metal Cross/Cold	LWS4-A11-H	LWS4-B11-H	LWS4-C11-H
Metal Cross/Hot	<b>LWS4-A12-H</b>	LWS4-B12-H	LWS4-C12-H
Plastic Cross/Cold	LWS4-A13-H	LWS4-B13-H	LWS4-C13-H
Plastic Cross/Hot	LWS4-A14-H	LWS4-B14-H	LWS4-C14-H
Wristblade/Cold	LWS4-A15-H	LWS4-B15-H	LWS4-C15-H
Wristblade/Hot	LWS4-A16-H	LWS4-B16-H	LWS4-C16-H

### Straight Nozzle With Aspirator

Handle/Index	Compression Cartridge	Ceramic Cartridge	Control-A-Flow Cartridge
Metal Cross/Cold	LWS4-A31-H	LWS4-B31-H	LWS4-C31-H
Metal Cross/Hot	LWS4-A32-H	LWS4-B32-H	LWS4-C32-H
Plastic Cross/Cold	LWS4-A33-H	LWS4-B33-H	LWS4-C33-H
Plastic Cross/Hot	LWS4-A34-H	LWS4-B34-H	LWS4-C34-H
Wristblade/Cold	LWS4-A35-H	LWS4-B35-H	LWS4-C35-H
Wristblade/Hot	LWS4-A36-H	LWS4-B36-H	LWS4-C36-H

## Wall Mounted, 5-1/4" Gooseneck Spout, with Shank

- Solid brass construction
- Polished chrome plated finish
- 1/2" NPT male thread shank assembly with integral flange



### 2.2 GPM Aerated Outlet

Handle/Index	Compression Cartridge	Ceramic Cartridge	Control-A-Flow Cartridge
Metal Cross/Cold	LWS5-A21-A	LWS5-B21-A	LWS5-C21-A
Metal Cross/Hot	LWS5-A22-A	LWS5-B22-A	LWS5-C22-A
Plastic Cross/Cold	LWS5-A23-A	LWS5-B23-A	LWS5-C23-A
Plastic Cross/Hot	LWS5-A24-A	LWS5-B24-A	LWS5-C24-A
Wristblade/Cold	LWS5-A25-A	LWS5-B25-A	LWS5-C25-A
Wristblade/Hot	LWS5-A26-A	LWS5-B26-A	LWS5-C26-A

### Straight Nozzle

Handle/Index	Compression Cartridge	Ceramic Cartridge	Control-A-Flow Cartridge
Metal Cross/Cold	<b>LWS5-A11-A</b>	LWS5-B11-A	LWS5-C11-A
Metal Cross/Hot	LWS5-A12-A	LWS5-B12-A	LWS5-C12-A
Plastic Cross/Cold	LWS5-A13-A	LWS5-B13-A	LWS5-C13-A
Plastic Cross/Hot	LWS5-A14-A	LWS5-B14-A	LWS5-C14-A
Wristblade/Cold	LWS5-A15-A	LWS5-B15-A	LWS5-C15-A
Wristblade/Hot	LWS5-A16-A	LWS5-B16-A	LWS5-C16-A

### Straight Nozzle With Aspirator

Handle/Index	Compression Cartridge	Ceramic Cartridge	Control-A-Flow Cartridge
Metal Cross/Cold	LWS5-A31-A	LWS5-B31-A	LWS5-C31-A
Metal Cross/Hot	LWS5-A32-A	LWS5-B32-A	LWS5-C32-A
Plastic Cross/Cold	LWS5-A33-A	LWS5-B33-A	LWS5-C33-A
Plastic Cross/Hot	LWS5-A34-A	LWS5-B34-A	LWS5-C34-A
Wristblade/Cold	LWS5-A35-A	LWS5-B35-A	LWS5-C35-A
Wristblade/Hot	LWS5-A36-A	LWS5-B36-A	LWS5-C36-A

## Wall Mounted, 8" Gooseneck Spout, with Shank

- Solid brass construction
- Polished chrome plated finish
- 1/2" NPT male thread shank assembly with integral flange



### 2.2 GPM Aerated Outlet

Handle/Index	Compression Cartridge	Ceramic Cartridge	Control-A-Flow Cartridge
Metal Cross/Cold	LWS5-A21-B	LWS5-B21-B	LWS5-C21-B
Metal Cross/Hot	LWS5-A22-B	LWS5-B22-B	LWS5-C22-B
Plastic Cross/Cold	LWS5-A23-B	LWS5-B23-B	LWS5-C23-B
Plastic Cross/Hot	LWS5-A24-B	<b>LWS5-B24-B</b>	LWS5-C24-B
Wristblade/Cold	LWS5-A25-B	LWS5-B25-B	LWS5-C25-B
Wristblade/Hot	LWS5-A26-B	LWS5-B26-B	LWS5-C26-B

### Straight Nozzle

Handle/Index	Compression Cartridge	Ceramic Cartridge	Control-A-Flow Cartridge
Metal Cross/Cold	LWS5-A11-B	LWS5-B11-B	LWS5-C11-B
Metal Cross/Hot	LWS5-A12-B	LWS5-B12-B	LWS5-C12-B
Plastic Cross/Cold	LWS5-A13-B	LWS5-B13-B	LWS5-C13-B
Plastic Cross/Hot	LWS5-A14-B	LWS5-B14-B	LWS5-C14-B
Wristblade/Cold	LWS5-A15-B	LWS5-B15-B	LWS5-C15-B
Wristblade/Hot	LWS5-A16-B	LWS5-B16-B	LWS5-C16-B

### Straight Nozzle With Aspirator

Handle/Index	Compression Cartridge	Ceramic Cartridge	Control-A-Flow Cartridge
Metal Cross/Cold	LWS5-A31-B	LWS5-B31-B	LWS5-C31-B
Metal Cross/Hot	LWS5-A32-B	LWS5-B32-B	LWS5-C32-B
Plastic Cross/Cold	LWS5-A33-B	LWS5-B33-B	LWS5-C33-B
Plastic Cross/Hot	LWS5-A34-B	LWS5-B34-B	LWS5-C34-B
Wristblade/Cold	LWS5-A35-B	LWS5-B35-B	LWS5-C35-B
Wristblade/Hot	LWS5-A36-B	LWS5-B36-B	LWS5-C36-B

## Wall Mounted, 5-1/4" Gooseneck Spout with Vacuum Breaker, with Shank

- Solid brass construction
- Polished chrome plated finish
- 1/2" NPT male thread shank assembly with integral flange



### 2.2 GPM Aerated Outlet

Handle/Index	Compression Cartridge	Ceramic Cartridge	Control-A-Flow Cartridge
Metal Cross/Cold	LWS5-A21-E	LWS5-B21-E	LWS5-C21-E
Metal Cross/Hot	LWS5-A22-E	LWS5-B22-E	LWS5-C22-E
Plastic Cross/Cold	LWS5-A23-E	LWS5-B23-E	LWS5-C23-E
Plastic Cross/Hot	LWS5-A24-E	LWS5-B24-E	LWS5-C24-E
Wristblade/Cold	LWS5-A25-E	LWS5-B25-E	LWS5-C25-E
Wristblade/Hot	LWS5-A26-E	LWS5-B26-E	LWS5-C26-E

### Straight Nozzle

Handle/Index	Compression Cartridge	Ceramic Cartridge	Control-A-Flow Cartridge
Metal Cross/Cold	LWS5-A11-E	LWS5-B11-E	LWS5-C11-E
Metal Cross/Hot	LWS5-A12-E	LWS5-B12-E	LWS5-C12-E
Plastic Cross/Cold	<b>LWS5-A13-E</b>	LWS5-B13-E	LWS5-C13-E
Plastic Cross/Hot	LWS5-A14-E	LWS5-B14-E	LWS5-C14-E
Wristblade/Cold	LWS5-A15-E	LWS5-B15-E	LWS5-C15-E
Wristblade/Hot	LWS5-A16-E	LWS5-B16-E	LWS5-C16-E

### Straight Nozzle With Aspirator

Handle/Index	Compression Cartridge	Ceramic Cartridge	Control-A-Flow Cartridge
Metal Cross/Cold	LWS5-A31-E	LWS5-B31-E	LWS5-C31-E
Metal Cross/Hot	LWS5-A32-E	LWS5-B32-E	LWS5-C32-E
Plastic Cross/Cold	LWS5-A33-E	LWS5-B33-E	LWS5-C33-E
Plastic Cross/Hot	LWS5-A34-E	LWS5-B34-E	LWS5-C34-E
Wristblade/Cold	LWS5-A35-E	LWS5-B35-E	LWS5-C35-E
Wristblade/Hot	LWS5-A36-E	LWS5-B36-E	LWS5-C36-E

## Wall Mounted, 8" Gooseneck Spout with Vacuum Breaker, with Shank

- Solid brass construction
- Polished chrome plated finish
- 1/2" NPT male thread shank assembly with integral flange



### 2.2 GPM Aerated Outlet

Handle/Index	Compression Cartridge	Ceramic Cartridge	Control-A-Flow Cartridge
Metal Cross/Cold	LWS5-A21-F	LWS5-B21-F	LWS5-C21-F
Metal Cross/Hot	LWS5-A22-F	LWS5-B22-F	LWS5-C22-F
Plastic Cross/Cold	LWS5-A23-F	LWS5-B23-F	LWS5-C23-F
Plastic Cross/Hot	LWS5-A24-F	<b>LWS5-B24-F</b>	LWS5-C24-F
Wristblade/Cold	LWS5-A25-F	LWS5-B25-F	LWS5-C25-F
Wristblade/Hot	LWS5-A26-F	LWS5-B26-F	LWS5-C26-F

### Straight Nozzle

Handle/Index	Compression Cartridge	Ceramic Cartridge	Control-A-Flow Cartridge
Metal Cross/Cold	LWS5-A11-F	LWS5-B11-F	LWS5-C11-F
Metal Cross/Hot	LWS5-A12-F	LWS5-B12-F	LWS5-C12-F
Plastic Cross/Cold	LWS5-A13-F	LWS5-B13-F	LWS5-C13-F
Plastic Cross/Hot	LWS5-A14-F	LWS5-B14-F	LWS5-C14-F
Wristblade/Cold	LWS5-A15-F	LWS5-B15-F	LWS5-C15-F
Wristblade/Hot	LWS5-A16-F	LWS5-B16-F	LWS5-C16-F

### Straight Nozzle With Aspirator

Handle/Index	Compression Cartridge	Ceramic Cartridge	Control-A-Flow Cartridge
Metal Cross/Cold	LWS5-A31-F	LWS5-B31-F	LWS5-C31-F
Metal Cross/Hot	LWS5-A32-F	LWS5-B32-F	LWS5-C32-F
Plastic Cross/Cold	LWS5-A33-F	LWS5-B33-F	LWS5-C33-F
Plastic Cross/Hot	LWS5-A34-F	LWS5-B34-F	LWS5-C34-F
Wristblade/Cold	LWS5-A35-F	LWS5-B35-F	LWS5-C35-F
Wristblade/Hot	LWS5-A36-F	LWS5-B36-F	LWS5-C36-F

## Wall Mounted, 5-1/4" Rigid Spout with Vacuum Breaker, with Shank

- Solid brass construction
- Polished chrome plated finish
- 1/2" NPT male thread shank assembly with integral flange



### 2.2 GPM Aerated Outlet

Handle/Index	Compression Cartridge	Ceramic Cartridge	Control-A-Flow Cartridge
Metal Cross/Cold	LWS5-A21-G	LWS5-B21-G	LWS5-C21-G
Metal Cross/Hot	LWS5-A22-G	LWS5-B22-G	LWS5-C22-G
Plastic Cross/Cold	LWS5-A23-G	LWS5-B23-G	LWS5-C23-G
Plastic Cross/Hot	LWS5-A24-G	LWS5-B24-G	LWS5-C24-G
Wristblade/Cold	LWS5-A25-G	LWS5-B25-G	LWS5-C25-G
Wristblade/Hot	LWS5-A26-G	LWS5-B26-G	LWS5-C26-G

### Straight Nozzle

Handle/Index	Compression Cartridge	Ceramic Cartridge	Control-A-Flow Cartridge
Metal Cross/Cold	LWS5-A11-G	LWS5-B11-G	LWS5-C11-G
Metal Cross/Hot	LWS5-A12-G	LWS5-B12-G	LWS5-C12-G
Plastic Cross/Cold	LWS5-A13-G	LWS5-B13-G	LWS5-C13-G
Plastic Cross/Hot	LWS5-A14-G	LWS5-B14-G	LWS5-C14-G
Wristblade/Cold	LWS5-A15-G	LWS5-B15-G	LWS5-C15-G
Wristblade/Hot	LWS5-A16-G	LWS5-B16-G	LWS5-C16-G

### Straight Nozzle With Aspirator

Handle/Index	Compression Cartridge	Ceramic Cartridge	Control-A-Flow Cartridge
Metal Cross/Cold	<b>LWS5-A31-G</b>	LWS5-B31-G	LWS5-C31-G
Metal Cross/Hot	LWS5-A32-G	LWS5-B32-G	LWS5-C32-G
Plastic Cross/Cold	LWS5-A33-G	LWS5-B33-G	LWS5-C33-G
Plastic Cross/Hot	LWS5-A34-G	LWS5-B34-G	LWS5-C34-G
Wristblade/Cold	LWS5-A35-G	LWS5-B35-G	LWS5-C35-G
Wristblade/Hot	LWS5-A36-G	LWS5-B36-G	LWS5-C36-G

## Wall Mounted, 8" Rigid Spout with Vacuum Breaker, with Shank

- Solid brass construction
- Polished chrome plated finish
- 1/2" NPT male thread shank assembly with integral flange



### 2.2 GPM Aerated Outlet

Handle/Index	Compression Cartridge	Ceramic Cartridge	Control-A-Flow Cartridge
Metal Cross/Cold	LWS5-A21-H	LWS5-B21-H	LWS5-C21-H
Metal Cross/Hot	LWS5-A22-H	LWS5-B22-H	LWS5-C22-H
Plastic Cross/Cold	LWS5-A23-H	LWS5-B23-H	LWS5-C23-H
Plastic Cross/Hot	LWS5-A24-H	LWS5-B24-H	LWS5-C24-H
Wristblade/Cold	LWS5-A25-H	LWS5-B25-H	LWS5-C25-H
Wristblade/Hot	LWS5-A26-H	LWS5-B26-H	LWS5-C26-H

### Straight Nozzle

Handle/Index	Compression Cartridge	Ceramic Cartridge	Control-A-Flow Cartridge
Metal Cross/Cold	LWS5-A11-H	LWS5-B11-H	LWS5-C11-H
Metal Cross/Hot	LWS5-A12-H	LWS5-B12-H	LWS5-C12-H
Plastic Cross/Cold	LWS5-A13-H	LWS5-B13-H	LWS5-C13-H
Plastic Cross/Hot	LWS5-A14-H	LWS5-B14-H	LWS5-C14-H
Wristblade/Cold	LWS5-A15-H	LWS5-B15-H	LWS5-C15-H
Wristblade/Hot	LWS5-A16-H	LWS5-B16-H	<b>LWS5-C16-H</b>

### Straight Nozzle With Aspirator

Handle/Index	Compression Cartridge	Ceramic Cartridge	Control-A-Flow Cartridge
Metal Cross/Cold	LWS5-A31-H	LWS5-B31-H	LWS5-C31-H
Metal Cross/Hot	LWS5-A32-H	LWS5-B32-H	LWS5-C32-H
Plastic Cross/Cold	LWS5-A33-H	LWS5-B33-H	LWS5-C33-H
Plastic Cross/Hot	LWS5-A34-H	LWS5-B34-H	LWS5-C34-H
Wristblade/Cold	LWS5-A35-H	LWS5-B35-H	LWS5-C35-H
Wristblade/Hot	LWS5-A36-H	LWS5-B36-H	LWS5-C36-H

## Deck Mounted, Turret with Front-Mount Handle, 5-1/4" Gooseneck Spout

- Solid brass construction
- Polished chrome plated finish
- 1/2" NPSM supply inlet with coupling nut for 3/8" or 1/2" flexible riser



### 2.2 GPM Aerated Outlet

Handle/Index	Compression Cartridge	Ceramic Cartridge	Control-A-Flow Cartridge
Metal Cross/Cold	LWS6-A21-A	LWS6-B21-A	LWS6-C21-A
Metal Cross/Hot	LWS6-A22-A	LWS6-B22-A	LWS6-C22-A
Plastic Cross/Cold	LWS6-A23-A	LWS6-B23-A	LWS6-C23-A
Plastic Cross/Hot	LWS6-A24-A	LWS6-B24-A	LWS6-C24-A
Wristblade/Cold	LWS6-A25-A	LWS6-B25-A	LWS6-C25-A
Wristblade/Hot	LWS6-A26-A	LWS6-B26-A	LWS6-C26-A

### Straight Nozzle

Handle/Index	Compression Cartridge	Ceramic Cartridge	Control-A-Flow Cartridge
Metal Cross/Cold	<b>LWS6-A11-A</b>	LWS6-B11-A	LWS6-C11-A
Metal Cross/Hot	LWS6-A12-A	LWS6-B12-A	LWS6-C12-A
Plastic Cross/Cold	LWS6-A13-A	LWS6-B13-A	LWS6-C13-A
Plastic Cross/Hot	LWS6-A14-A	LWS6-B14-A	LWS6-C14-A
Wristblade/Cold	LWS6-A15-A	LWS6-B15-A	LWS6-C15-A
Wristblade/Hot	LWS6-A16-A	LWS6-B16-A	LWS6-C16-A

### Straight Nozzle With Aspirator

Handle/Index	Compression Cartridge	Ceramic Cartridge	Control-A-Flow Cartridge
Metal Cross/Cold	LWS6-A31-A	LWS6-B31-A	LWS6-C31-A
Metal Cross/Hot	LWS6-A32-A	LWS6-B32-A	LWS6-C32-A
Plastic Cross/Cold	LWS6-A33-A	LWS6-B33-A	LWS6-C33-A
Plastic Cross/Hot	LWS6-A34-A	LWS6-B34-A	LWS6-C34-A
Wristblade/Cold	LWS6-A35-A	LWS6-B35-A	LWS6-C35-A
Wristblade/Hot	LWS6-A36-A	LWS6-B36-A	LWS6-C36-A

## Deck Mounted, Turret with Front-Mount Handle, 8" Gooseneck Spout

- Solid brass construction
- Polished chrome plated finish
- 1/2" NPSM supply inlet with coupling nut for 3/8" or 1/2" flexible riser



### 2.2 GPM Aerated Outlet

Handle/Index	Compression Cartridge	Ceramic Cartridge	Control-A-Flow Cartridge
Metal Cross/Cold	LWS6-A21-B	LWS6-B21-B	LWS6-C21-B
Metal Cross/Hot	<b>LWS6-A22-B</b>	LWS6-B22-B	LWS6-C22-B
Plastic Cross/Cold	LWS6-A23-B	LWS6-B23-B	LWS6-C23-B
Plastic Cross/Hot	LWS6-A24-B	LWS6-B24-B	LWS6-C24-B
Wristblade/Cold	LWS6-A25-B	LWS6-B25-B	LWS6-C25-B
Wristblade/Hot	LWS6-A26-B	LWS6-B26-B	LWS6-C26-B

### Straight Nozzle

Handle/Index	Compression Cartridge	Ceramic Cartridge	Control-A-Flow Cartridge
Metal Cross/Cold	LWS6-A11-B	LWS6-B11-B	LWS6-C11-B
Metal Cross/Hot	LWS6-A12-B	LWS6-B12-B	LWS6-C12-B
Plastic Cross/Cold	LWS6-A13-B	LWS6-B13-B	LWS6-C13-B
Plastic Cross/Hot	LWS6-A14-B	LWS6-B14-B	LWS6-C14-B
Wristblade/Cold	LWS6-A15-B	LWS6-B15-B	LWS6-C15-B
Wristblade/Hot	LWS6-A16-B	LWS6-B16-B	LWS6-C16-B

### Straight Nozzle With Aspirator

Handle/Index	Compression Cartridge	Ceramic Cartridge	Control-A-Flow Cartridge
Metal Cross/Cold	LWS6-A31-B	LWS6-B31-B	LWS6-C31-B
Metal Cross/Hot	LWS6-A32-B	LWS6-B32-B	LWS6-C32-B
Plastic Cross/Cold	LWS6-A33-B	LWS6-B33-B	LWS6-C33-B
Plastic Cross/Hot	LWS6-A34-B	LWS6-B34-B	LWS6-C34-B
Wristblade/Cold	LWS6-A35-B	LWS6-B35-B	LWS6-C35-B
Wristblade/Hot	LWS6-A36-B	LWS6-B36-B	LWS6-C36-B



## Deck Mounted, Turret with Front-Mount Handle, 5-1/4" Gooseneck Spout with Vacuum Breaker

- Solid brass construction
- Polished chrome plated finish
- 1/2" NPSM supply inlet with coupling nut for 3/8" or 1/2" flexible riser



### 2.2 GPM Aerated Outlet

Handle/Index	Compression Cartridge	Ceramic Cartridge	Control-A-Flow Cartridge
Metal Cross/Cold	LWS6-A21-E	LWS6-B21-E	LWS6-C21-E
Metal Cross/Hot	LWS6-A22-E	LWS6-B22-E	LWS6-C22-E
Plastic Cross/Cold	LWS6-A23-E	<b>LWS6-B23-E</b>	LWS6-C23-E
Plastic Cross/Hot	LWS6-A24-E	LWS6-B24-E	LWS6-C24-E
Wristblade/Cold	LWS6-A25-E	LWS6-B25-E	LWS6-C25-E
Wristblade/Hot	LWS6-A26-E	LWS6-B26-E	LWS6-C26-E

### Straight Nozzle

Handle/Index	Compression Cartridge	Ceramic Cartridge	Control-A-Flow Cartridge
Metal Cross/Cold	LWS6-A11-E	LWS6-B11-E	LWS6-C11-E
Metal Cross/Hot	LWS6-A12-E	LWS6-B12-E	LWS6-C12-E
Plastic Cross/Cold	LWS6-A13-E	LWS6-B13-E	LWS6-C13-E
Plastic Cross/Hot	LWS6-A14-E	LWS6-B14-E	LWS6-C14-E
Wristblade/Cold	LWS6-A15-E	LWS6-B15-E	LWS6-C15-E
Wristblade/Hot	LWS6-A16-E	LWS6-B16-E	LWS6-C16-E

### Straight Nozzle With Aspirator

Handle/Index	Compression Cartridge	Ceramic Cartridge	Control-A-Flow Cartridge
Metal Cross/Cold	LWS6-A31-E	LWS6-B31-E	LWS6-C31-E
Metal Cross/Hot	LWS6-A32-E	LWS6-B32-E	LWS6-C32-E
Plastic Cross/Cold	LWS6-A33-E	LWS6-B33-E	LWS6-C33-E
Plastic Cross/Hot	LWS6-A34-E	LWS6-B34-E	LWS6-C34-E
Wristblade/Cold	LWS6-A35-E	LWS6-B35-E	LWS6-C35-E
Wristblade/Hot	LWS6-A36-E	LWS6-B36-E	LWS6-C36-E

## Deck Mounted, Turret with Front-Mount Handle, 8" Gooseneck Spout with Vacuum Breaker

- Solid brass construction
- Polished chrome plated finish
- 1/2" NPSM supply inlet with coupling nut for 3/8" or 1/2" flexible riser



### 2.2 GPM Aerated Outlet

Handle/Index	Compression Cartridge	Ceramic Cartridge	Control-A-Flow Cartridge
Metal Cross/Cold	LWS6-A21-F	LWS6-B21-F	LWS6-C21-F
Metal Cross/Hot	LWS6-A22-F	<b>LWS6-B22-F</b>	LWS6-C22-F
Plastic Cross/Cold	LWS6-A23-F	LWS6-B23-F	LWS6-C23-F
Plastic Cross/Hot	LWS6-A24-F	LWS6-B24-F	LWS6-C24-F
Wristblade/Cold	LWS6-A25-F	LWS6-B25-F	LWS6-C25-F
Wristblade/Hot	LWS6-A26-F	LWS6-B26-F	LWS6-C26-F

### Straight Nozzle

Handle/Index	Compression Cartridge	Ceramic Cartridge	Control-A-Flow Cartridge
Metal Cross/Cold	LWS6-A11-F	LWS6-B11-F	LWS6-C11-F
Metal Cross/Hot	LWS6-A12-F	LWS6-B12-F	LWS6-C12-F
Plastic Cross/Cold	LWS6-A13-F	LWS6-B13-F	LWS6-C13-F
Plastic Cross/Hot	LWS6-A14-F	LWS6-B14-F	LWS6-C14-F
Wristblade/Cold	LWS6-A15-F	LWS6-B15-F	LWS6-C15-F
Wristblade/Hot	LWS6-A16-F	LWS6-B16-F	LWS6-C16-F

### Straight Nozzle With Aspirator

Handle/Index	Compression Cartridge	Ceramic Cartridge	Control-A-Flow Cartridge
Metal Cross/Cold	LWS6-A31-F	LWS6-B31-F	LWS6-C31-F
Metal Cross/Hot	LWS6-A32-F	LWS6-B32-F	LWS6-C32-F
Plastic Cross/Cold	LWS6-A33-F	LWS6-B33-F	LWS6-C33-F
Plastic Cross/Hot	LWS6-A34-F	LWS6-B34-F	LWS6-C34-F
Wristblade/Cold	LWS6-A35-F	LWS6-B35-F	LWS6-C35-F
Wristblade/Hot	LWS6-A36-F	LWS6-B36-F	LWS6-C36-F

## Deck Mounted, Turret with Front-Mount Handle, 5-1/4" Rigid Spout with Vacuum Breaker

- Solid brass construction
- Polished chrome plated finish
- 1/2" NPSM supply inlet with coupling nut for 3/8" or 1/2" flexible riser



### 2.2 GPM Aerated Outlet

Handle/Index	Compression Cartridge	Ceramic Cartridge	Control-A-Flow Cartridge
Metal Cross/Cold	LWS6-A21-G	LWS6-B21-G	LWS6-C21-G
Metal Cross/Hot	LWS6-A22-G	LWS6-B22-G	LWS6-C22-G
Plastic Cross/Cold	LWS6-A23-G	LWS6-B23-G	LWS6-C23-G
Plastic Cross/Hot	LWS6-A24-G	LWS6-B24-G	LWS6-C24-G
Wristblade/Cold	LWS6-A25-G	LWS6-B25-G	LWS6-C25-G
Wristblade/Hot	LWS6-A26-G	LWS6-B26-G	LWS6-C26-G

### Straight Nozzle

Handle/Index	Compression Cartridge	Ceramic Cartridge	Control-A-Flow Cartridge
Metal Cross/Cold	LWS6-A11-G	LWS6-B11-G	LWS6-C11-G
Metal Cross/Hot	LWS6-A12-G	LWS6-B12-G	LWS6-C12-G
Plastic Cross/Cold	LWS6-A13-G	LWS6-B13-G	LWS6-C13-G
Plastic Cross/Hot	LWS6-A14-G	LWS6-B14-G	LWS6-C14-G
Wristblade/Cold	LWS6-A15-G	<b>LWS6-B15-G</b>	LWS6-C15-G
Wristblade/Hot	LWS6-A16-G	LWS6-B16-G	LWS6-C16-G

### Straight Nozzle With Aspirator

Handle/Index	Compression Cartridge	Ceramic Cartridge	Control-A-Flow Cartridge
Metal Cross/Cold	LWS6-A31-G	LWS6-B31-G	LWS6-C31-G
Metal Cross/Hot	LWS6-A32-G	LWS6-B32-G	LWS6-C32-G
Plastic Cross/Cold	LWS6-A33-G	LWS6-B33-G	LWS6-C33-G
Plastic Cross/Hot	LWS6-A34-G	LWS6-B34-G	LWS6-C34-G
Wristblade/Cold	LWS6-A35-G	LWS6-B35-G	LWS6-C35-G
Wristblade/Hot	LWS6-A36-G	LWS6-B36-G	LWS6-C36-G

## Deck Mounted, Turret with Front-Mount Handle, 8" Rigid Spout with Vacuum Breaker

- Solid brass construction
- Polished chrome plated finish
- 1/2" NPSM supply inlet with coupling nut for 3/8" or 1/2" flexible riser



### 2.2 GPM Aerated Outlet

Handle/Index	Compression Cartridge	Ceramic Cartridge	Control-A-Flow Cartridge
Metal Cross/Cold	LWS6-A21-H	LWS6-B21-H	LWS6-C21-H
Metal Cross/Hot	LWS6-A22-H	LWS6-B22-H	LWS6-C22-H
Plastic Cross/Cold	LWS6-A23-H	LWS6-B23-H	LWS6-C23-H
Plastic Cross/Hot	LWS6-A24-H	LWS6-B24-H	LWS6-C24-H
Wristblade/Cold	LWS6-A25-H	LWS6-B25-H	LWS6-C25-H
Wristblade/Hot	LWS6-A26-H	LWS6-B26-H	LWS6-C26-H

### Straight Nozzle

Handle/Index	Compression Cartridge	Ceramic Cartridge	Control-A-Flow Cartridge
Metal Cross/Cold	LWS6-A11-H	LWS6-B11-H	LWS6-C11-H
Metal Cross/Hot	LWS6-A12-H	LWS6-B12-H	LWS6-C12-H
Plastic Cross/Cold	LWS6-A13-H	LWS6-B13-H	LWS6-C13-H
Plastic Cross/Hot	LWS6-A14-H	LWS6-B14-H	LWS6-C14-H
Wristblade/Cold	LWS6-A15-H	LWS6-B15-H	LWS6-C15-H
Wristblade/Hot	LWS6-A16-H	LWS6-B16-H	LWS6-C16-H

### Straight Nozzle With Aspirator

Handle/Index	Compression Cartridge	Ceramic Cartridge	Control-A-Flow Cartridge
Metal Cross/Cold	LWS6-A31-H	LWS6-B31-H	LWS6-C31-H
Metal Cross/Hot	LWS6-A32-H	LWS6-B32-H	LWS6-C32-H
Plastic Cross/Cold	LWS6-A33-H	LWS6-B33-H	LWS6-C33-H
Plastic Cross/Hot	LWS6-A34-H	<b>LWS6-B34-H</b>	LWS6-C34-H
Wristblade/Cold	LWS6-A35-H	LWS6-B35-H	LWS6-C35-H
Wristblade/Hot	LWS6-A36-H	LWS6-B36-H	LWS6-C36-H



## How to build and order a Chicago Faucets laboratory water mixing faucet.

Chicago Faucets makes it easy for you to build a water mixing faucet that meets your exact requirements. You can reference the charts on the following pages, or you can build your own faucet by choosing the components below to configure your model number.

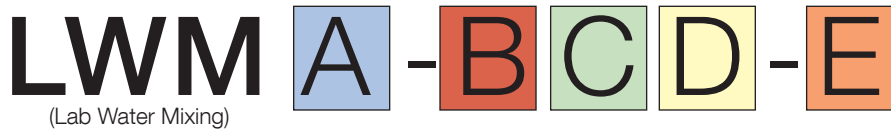

### Base

A

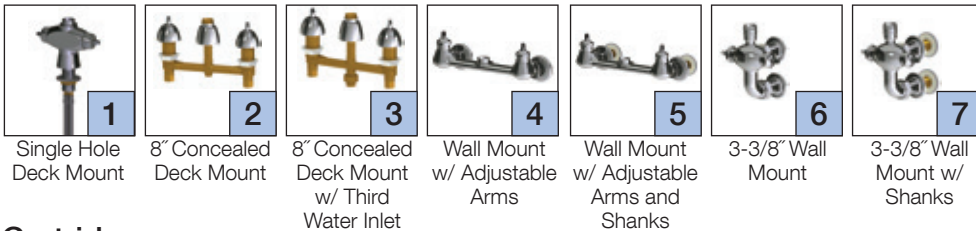

### Cartridge

B

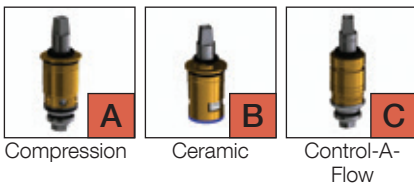

### Outlet

C

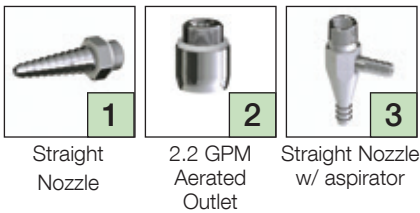

### Handles

D

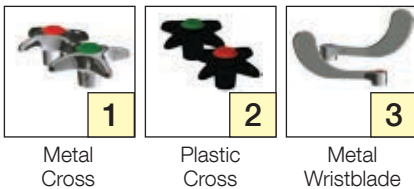

### Spouts

E

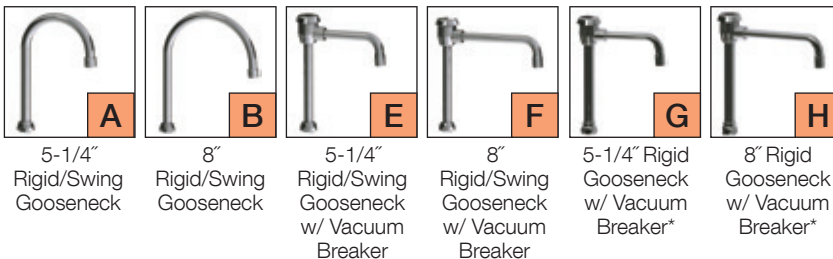

**EXAMPLE**



**LWM2-A11-A**  
8" concealed deck mount, compression cartridge, straight nozzle, metal cross handles, and 5-1/4" gooseneck spout.

*\*Rigid spouts can not be used on base number 2 or base number 3.*

## Deck Mounted, Single Hole, with 5-1/4" Gooseneck Spout



- Solid brass construction
- Polished chrome plated finish
- 3/8" compression stainless steel hoses
- Gooseneck spout includes rigid/swing option

### 2.2 GPM Aerated Outlet

Handle	Compression Cartridge	Ceramic Cartridge	Control-A-Flow Cartridge
Metal Cross	<b>LWM1-A21-A</b>	LWM1-B21-A	LWM1-C21-A
Plastic Cross	LWM1-A22-A	LWM1-B22-A	LWM1-C22-A
Metal Wristblade	LWM1-A23-A	LWM1-B23-A	LWM1-C23-A

### Straight Nozzle

Handle	Compression Cartridge	Ceramic Cartridge	Control-A-Flow Cartridge
Metal Cross	LWM1-A11-A	LWM1-B11-A	LWM1-C11-A
Plastic Cross	LWM1-A12-A	LWM1-B12-A	LWM1-C12-A
Metal Wristblade	LWM1-A13-A	LWM1-B13-A	LWM1-C13-A

### Straight Nozzle With Aspirator

Handle	Compression Cartridge	Ceramic Cartridge	Control-A-Flow Cartridge
Metal Cross	LWM1-A31-A	LWM1-B31-A	LWM1-C31-A
Plastic Cross	LWM1-A32-A	LWM1-B32-A	LWM1-C32-A
Metal Wristblade	LWM1-A33-A	LWM1-B33-A	LWM1-C33-A

## Deck Mounted, Single Hole, with 8" Gooseneck Spout



- Solid brass construction
- Polished chrome plated finish
- 3/8" compression stainless steel hoses
- Gooseneck spout includes rigid/swing option

### 2.2 GPM Aerated Outlet

Handle	Compression Cartridge	Ceramic Cartridge	Control-A-Flow Cartridge
Metal Cross	LWM1-A21-B	LWM1-B21-B	LWM1-C21-B
Plastic Cross	LWM1-A22-B	LWM1-B22-B	LWM1-C22-B
Metal Wristblade	LWM1-A23-B	LWM1-B23-B	LWM1-C23-B

### Straight Nozzle

Handle	Compression Cartridge	Ceramic Cartridge	Control-A-Flow Cartridge
Metal Cross	LWM1-A11-B	LWM1-B11-B	LWM1-C11-B
Plastic Cross	LWM1-A12-B	LWM1-B12-B	LWM1-C12-B
Metal Wristblade	LWM1-A13-B	<b>LWM1-B13-B</b>	LWM1-C13-B

### Straight Nozzle With Aspirator

Handle	Compression Cartridge	Ceramic Cartridge	Control-A-Flow Cartridge
Metal Cross	LWM1-A31-B	LWM1-B31-B	LWM1-C31-B
Plastic Cross	LWM1-A32-B	LWM1-B32-B	LWM1-C32-B
Metal Wristblade	LWM1-A33-B	LWM1-B33-B	LWM1-C33-B

## Deck Mounted, Single Hole, 5-1/4" Gooseneck Spout with Vacuum Breaker

- Solid brass construction
- Polished chrome plated finish
- 3/8" compression stainless steel hoses
- Gooseneck spout includes rigid/swing option



### Straight Nozzle

Handle	Compression Cartridge	Ceramic Cartridge	Control-A-Flow Cartridge
Metal Cross	LWM1-A11-E	LWM1-B11-E	LWM1-C11-E
Plastic Cross	LWM1-A12-E	LWM1-B12-E	LWM1-C12-E
Metal Wristblade	LWM1-A13-E	LWM1-B13-E	LWM1-C13-E

### 2.2 GPM Aerated Outlet

Handle	Compression Cartridge	Ceramic Cartridge	Control-A-Flow Cartridge
Metal Cross	<b>LWM1-A21-E</b>	LWM1-B21-E	LWM1-C21-E
Plastic Cross	LWM1-A22-E	LWM1-B22-E	LWM1-C22-E
Metal Wristblade	LWM1-A23-E	LWM1-B23-E	LWM1-C23-E

### Straight Nozzle With Aspirator

Handle	Compression Cartridge	Ceramic Cartridge	Control-A-Flow Cartridge
Metal Cross	LWM1-A31-E	LWM1-B31-E	LWM1-C31-E
Plastic Cross	LWM1-A32-E	LWM1-B32-E	LWM1-C32-E
Metal Wristblade	LWM1-A33-E	LWM1-B33-E	LWM1-C33-E

## Deck Mounted, Single Hole, 8" Gooseneck Spout with Vacuum Breaker

- Solid brass construction
- Polished chrome plated finish
- 3/8" compression stainless steel hoses
- Gooseneck spout includes rigid/swing option



### Straight Nozzle

Handle	Compression Cartridge	Ceramic Cartridge	Control-A-Flow Cartridge
Metal Cross	LWM1-A11-F	LWM1-B11-F	LWM1-C11-F
Plastic Cross	LWM1-A12-F	LWM1-B12-F	LWM1-C12-F
Metal Wristblade	LWM1-A13-F	LWM1-B13-F	LWM1-C13-F

### 2.2 GPM Aerated Outlet

Handle	Compression Cartridge	Ceramic Cartridge	Control-A-Flow Cartridge
Metal Cross	LWM1-A21-F	<b>LWM1-B21-F</b>	LWM1-C21-F
Plastic Cross	LWM1-A22-F	LWM1-B22-F	LWM1-C22-F
Metal Wristblade	LWM1-A23-F	LWM1-B23-F	LWM1-C23-F

### Straight Nozzle With Aspirator

Handle	Compression Cartridge	Ceramic Cartridge	Control-A-Flow Cartridge
Metal Cross	LWM1-A31-F	LWM1-B31-F	LWM1-C31-F
Plastic Cross	LWM1-A32-F	LWM1-B32-F	LWM1-C32-F
Metal Wristblade	LWM1-A33-F	LWM1-B33-F	LWM1-C33-F

## Deck Mounted, Single Hole, 5-1/4" Rigid Gooseneck Spout with Vacuum Breaker

- Solid brass construction
- Polished chrome plated finish
- 3/8" compression stainless steel hoses



Straight Nozzle

Handle	Compression Cartridge	Ceramic Cartridge	Control-A-Flow Cartridge
Metal Cross	LWM1-A11-G	LWM1-B11-G	LWM1-C11-G
Plastic Cross	LWM1-A12-G	<b>LWM1-B12-G</b>	LWM1-C12-G
Metal Wristblade	LWM1-A13-G	LWM1-B13-G	LWM1-C13-G

2.2 GPM Aerated Outlet

Handle	Compression Cartridge	Ceramic Cartridge	Control-A-Flow Cartridge
Metal Cross	LWM1-A21-G	LWM1-B21-G	LWM1-C21-G
Plastic Cross	LWM1-A22-G	LWM1-B22-G	LWM1-C22-G
Metal Wristblade	LWM1-A23-G	LWM1-B23-G	LWM1-C23-G

Straight Nozzle With Aspirator

Handle	Compression Cartridge	Ceramic Cartridge	Control-A-Flow Cartridge
Metal Cross	LWM1-A31-G	LWM1-B31-G	LWM1-C31-G
Plastic Cross	LWM1-A32-G	LWM1-B32-G	LWM1-C32-G
Metal Wristblade	LWM1-A33-G	LWM1-B33-G	LWM1-C33-G

## Deck Mounted, Single Hole, 8" Rigid Gooseneck Spout with Vacuum Breaker

- Solid brass construction
- Polished chrome plated finish
- 3/8" compression stainless steel hoses



Straight Nozzle

Handle	Compression Cartridge	Ceramic Cartridge	Control-A-Flow Cartridge
Metal Cross	LWM1-A11-H	LWM1-B11-H	LWM1-C11-H
Plastic Cross	LWM1-A12-H	LWM1-B12-H	LWM1-C12-H
Metal Wristblade	LWM1-A13-H	LWM1-B13-H	LWM1-C13-H

2.2 GPM Aerated Outlet

Handle	Compression Cartridge	Ceramic Cartridge	Control-A-Flow Cartridge
Metal Cross	<b>LWM1-A21-H</b>	LWM1-B21-H	LWM1-C21-H
Plastic Cross	LWM1-A22-H	LWM1-B22-H	LWM1-C22-H
Metal Wristblade	LWM1-A23-H	LWM1-B23-H	LWM1-C23-H

Straight Nozzle With Aspirator

Handle	Compression Cartridge	Ceramic Cartridge	Control-A-Flow Cartridge
Metal Cross	LWM1-A31-H	LWM1-B31-H	LWM1-C31-H
Plastic Cross	LWM1-A32-H	LWM1-B32-H	LWM1-C32-H
Metal Wristblade	LWM1-A33-H	LWM1-B33-H	LWM1-C33-H

## Deck Mounted, 8" Fixed Centers, with 5-1/4" Gooseneck Spout



- Solid brass construction
- Polished chrome plated finish
- 1/2" NPSM supply inlets and coupling nut for 3/8" or 1/2" flexible riser

### 2.2 GPM Aerated Outlet

Handle	Compression Cartridge	Ceramic Cartridge	Control-A-Flow Cartridge
Metal Cross	LWM2-A21-A	LWM2-B21-A	LWM2-C21-A
Plastic Cross	LWM2-A22-A	LWM2-B22-A	LWM2-C22-A
Metal Wristblade	LWM2-A23-A	LWM2-B23-A	LWM2-C23-A

### Straight Nozzle

Handle	Compression Cartridge	Ceramic Cartridge	Control-A-Flow Cartridge
Metal Cross	<b>LWM2-A11-A</b>	LWM2-B11-A	LWM2-C11-A
Plastic Cross	LWM2-A12-A	LWM2-B12-A	LWM2-C12-A
Metal Wristblade	LWM2-A13-A	LWM2-B13-A	LWM2-C13-A

### Straight Nozzle With Aspirator

Handle	Compression Cartridge	Ceramic Cartridge	Control-A-Flow Cartridge
Metal Cross	LWM2-A31-A	LWM2-B31-A	LWM2-C31-A
Plastic Cross	LWM2-A32-A	LWM2-B32-A	LWM2-C32-A
Metal Wristblade	LWM2-A33-A	LWM2-B33-A	LWM2-C33-A

## Deck Mounted, 8" Fixed Centers, with 8" Gooseneck Spout



- Solid brass construction
- Polished chrome plated finish
- 1/2" NPSM supply inlets and coupling nut for 3/8" or 1/2" flexible riser

### 2.2 GPM Aerated Outlet

Handle	Compression Cartridge	Ceramic Cartridge	Control-A-Flow Cartridge
Metal Cross	<b>LWM2-A21-B</b>	LWM2-B21-B	LWM2-C21-B
Plastic Cross	LWM2-A22-B	LWM2-B22-B	LWM2-C22-B
Metal Wristblade	LWM2-A23-B	LWM2-B23-B	LWM2-C23-B

### Straight Nozzle

Handle	Compression Cartridge	Ceramic Cartridge	Control-A-Flow Cartridge
Metal Cross	LWM2-A11-B	LWM2-B11-B	LWM2-C11-B
Plastic Cross	LWM2-A12-B	LWM2-B12-B	LWM2-C12-B
Metal Wristblade	LWM2-A13-B	LWM2-B13-B	LWM2-C13-B

### Straight Nozzle With Aspirator

Handle	Compression Cartridge	Ceramic Cartridge	Control-A-Flow Cartridge
Metal Cross	LWM2-A31-B	LWM2-B31-B	LWM2-C31-B
Plastic Cross	LWM2-A32-B	LWM2-B32-B	LWM2-C32-B
Metal Wristblade	LWM2-A33-B	LWM2-B33-B	LWM2-C33-B



## Deck Mounted, 8" Fixed Centers, 5-1/4" Gooseneck Spout with Vacuum Breaker



- Solid brass construction
- Polished chrome plated finish
- 1/2" NPSM supply inlets and coupling nut for 3/8" or 1/2" flexible riser

### 2.2 GPM Aerated Outlet

Handle	Compression Cartridge	Ceramic Cartridge	Control-A-Flow Cartridge
Metal Cross	LWM2-A21-E	LWM2-B21-E	LWM2-C21-E
Plastic Cross	<b>LWM2-A22-E</b>	LWM2-B22-E	LWM2-C22-E
Metal Wristblade	LWM2-A23-E	LWM2-B23-E	LWM2-C23-E

### Straight Nozzle

Handle	Compression Cartridge	Ceramic Cartridge	Control-A-Flow Cartridge
Metal Cross	LWM2-A11-E	LWM2-B11-E	LWM2-C11-E
Plastic Cross	LWM2-A12-E	LWM2-B12-E	LWM2-C12-E
Metal Wristblade	LWM2-A13-E	LWM2-B13-E	LWM2-C13-E

### Straight Nozzle With Aspirator

Handle	Compression Cartridge	Ceramic Cartridge	Control-A-Flow Cartridge
Metal Cross	LWM1-A31-E	LWM1-B31-E	LWM1-C31-E
Plastic Cross	LWM1-A32-E	LWM1-B32-E	LWM1-C32-E
Metal Wristblade	LWM1-A33-E	LWM1-B33-E	LWM1-C33-E

## Deck Mounted, 8" Fixed Centers, 8" Gooseneck Spout with Vacuum Breaker



- Solid brass construction
- Polished chrome plated finish
- 1/2" NPSM supply inlets and coupling nut for 3/8" or 1/2" flexible riser

### 2.2 GPM Aerated Outlet

Handle	Compression Cartridge	Ceramic Cartridge	Control-A-Flow Cartridge
Metal Cross	LWM2-A21-F	LWM2-B21-F	LWM2-C21-F
Plastic Cross	LWM2-A22-F	LWM2-B22-F	LWM2-C22-F
Metal Wristblade	LWM2-A23-F	LWM2-B23-F	LWM2-C23-F

### Straight Nozzle

Handle	Compression Cartridge	Ceramic Cartridge	Control-A-Flow Cartridge
Metal Cross	LWM2-A11-F	LWM2-B11-F	LWM2-C11-F
Plastic Cross	LWM2-A12-F	LWM2-B12-F	LWM2-C12-F
Metal Wristblade	LWM2-A13-F	<b>LWM2-B13-F</b>	LWM2-C13-F

### Straight Nozzle With Aspirator

Handle	Compression Cartridge	Ceramic Cartridge	Control-A-Flow Cartridge
Metal Cross	LWM2-A31-F	LWM2-B31-F	LWM2-C31-F
Plastic Cross	LWM2-A32-F	LWM2-B32-F	LWM2-C32-F
Metal Wristblade	LWM2-A33-F	LWM2-B33-F	LWM2-C33-F

## Deck Mounted, 8" Fixed Centers, Third Water Inlet, 5-1/4" Gooseneck Spout



- Solid brass construction
- Polished chrome plated finish
- 3/8" compression stainless steel hoses

### 2.2 GPM Aerated Outlet

Handle	Compression Cartridge	Ceramic Cartridge	Control-A-Flow Cartridge
Metal Cross	<b>LWM3-A21-A</b>	LWM3-B21-A	LWM3-C21-A
Plastic Cross	LWM3-A22-A	LWM3-B22-A	LWM3-C22-A
Metal Wristblade	LWM3-A23-A	LWM3-B23-A	LWM3-C23-A

### Straight Nozzle

Handle	Compression Cartridge	Ceramic Cartridge	Control-A-Flow Cartridge
Metal Cross	LWM3-A11-A	LWM3-B11-A	LWM3-C11-A
Plastic Cross	LWM3-A12-A	LWM3-B12-A	LWM3-C12-A
Metal Wristblade	LWM3-A13-A	LWM3-B13-A	LWM3-C13-A

### Straight Nozzle With Aspirator

Handle	Compression Cartridge	Ceramic Cartridge	Control-A-Flow Cartridge
Metal Cross	LWM3-A31-A	LWM3-B31-A	LWM3-C31-A
Plastic Cross	LWM3-A32-A	LWM3-B32-A	LWM3-C32-A
Metal Wristblade	LWM3-A33-A	LWM3-B33-A	LWM3-C33-A

## Deck Mounted, 8" Fixed Centers, Third Water Inlet, 8" Gooseneck Spout



- Solid brass construction
- Polished chrome plated finish
- 3/8" compression stainless steel hoses

### 2.2 GPM Aerated Outlet

Handle	Compression Cartridge	Ceramic Cartridge	Control-A-Flow Cartridge
Metal Cross	<b>LWM3-A21-B</b>	LWM3-B21-B	LWM3-C21-B
Plastic Cross	LWM3-A22-B	LWM3-B22-B	LWM3-C22-B
Metal Wristblade	LWM3-A23-B	LWM3-B23-B	LWM3-C23-B

### Straight Nozzle

Handle	Compression Cartridge	Ceramic Cartridge	Control-A-Flow Cartridge
Metal Cross	LWM3-A11-B	LWM3-B11-B	LWM3-C11-B
Plastic Cross	LWM3-A12-B	LWM3-B12-B	LWM3-C12-B
Metal Wristblade	LWM3-A13-B	LWM3-B13-B	LWM3-C13-B

### Straight Nozzle With Aspirator

Handle	Compression Cartridge	Ceramic Cartridge	Control-A-Flow Cartridge
Metal Cross	LWM3-A31-B	LWM3-B31-B	LWM3-C31-B
Plastic Cross	LWM3-A32-B	LWM3-B32-B	LWM3-C32-B
Metal Wristblade	LWM3-A33-B	LWM3-B33-B	LWM3-C33-B

## Deck Mounted, 8" Fixed Centers, Third Water Inlet, 5-1/4" Gooseneck Spout with Vacuum Breaker



- Solid brass construction
- Polished chrome plated finish
- 1/2" NPSM supply inlets and coupling nut for 3/8" or 1/2" flexible riser

### 2.2 GPM Aerated Outlet

Handle	Compression Cartridge	Ceramic Cartridge	Control-A-Flow Cartridge
Metal Cross	<b>LWM3-A21-E</b>	LWM3-B21-E	LWM3-C21-E
Plastic Cross	LWM3-A22-E	LWM3-B22-E	LWM3-C22-E
Metal Wristblade	LWM3-A23-E	LWM3-B23-E	LWM3-C23-E

### Straight Nozzle

Handle	Compression Cartridge	Ceramic Cartridge	Control-A-Flow Cartridge
Metal Cross	LWM3-A11-E	LWM3-B11-E	LWM3-C11-E
Plastic Cross	LWM3-A12-E	LWM3-B12-E	LWM3-C12-E
Metal Wristblade	LWM3-A13-E	LWM3-B13-E	LWM3-C13-E

### Straight Nozzle With Aspirator

Handle	Compression Cartridge	Ceramic Cartridge	Control-A-Flow Cartridge
Metal Cross	LWM3-A31-E	LWM3-B31-E	LWM3-C31-E
Plastic Cross	LWM3-A32-E	LWM3-B32-E	LWM3-C32-E
Metal Wristblade	LWM3-A33-E	LWM3-B33-E	LWM3-C33-E

## Deck Mounted, 8" Fixed Centers, Third Water Inlet, 8" Gooseneck Spout with Vacuum Breaker



- Solid brass construction
- Polished chrome plated finish
- 1/2" NPSM supply inlets and coupling nut for 3/8" or 1/2" flexible riser

### 2.2 GPM Aerated Outlet

Handle	Compression Cartridge	Ceramic Cartridge	Control-A-Flow Cartridge
Metal Cross	LWM3-A21-F	LWM3-B21-F	LWM3-C21-F
Plastic Cross	LWM3-A22-F	LWM3-B22-F	LWM3-C22-F
Metal Wristblade	LWM3-A23-F	LWM3-B23-F	LWM3-C23-F

### Straight Nozzle

Handle	Compression Cartridge	Ceramic Cartridge	Control-A-Flow Cartridge
Metal Cross	LWM3-A11-F	LWM3-B11-F	<b>LWM3-C11-F</b>
Plastic Cross	LWM3-A12-F	LWM3-B12-F	LWM3-C12-F
Metal Wristblade	LWM3-A13-F	LWM3-B13-F	LWM3-C13-F

### Straight Nozzle With Aspirator

Handle	Compression Cartridge	Ceramic Cartridge	Control-A-Flow Cartridge
Metal Cross	LWM3-A31-F	LWM3-B31-F	LWM3-C31-F
Plastic Cross	LWM3-A32-F	LWM3-B32-F	LWM3-C32-F
Metal Wristblade	LWM3-A33-F	LWM3-B33-F	LWM3-C33-F

## Wall Mounted with Adjustable Arms, 5-1/4" Gooseneck Spout



- Solid brass construction, polished chrome plated finish
- 8" Body, adjustable arms 7-1/4" - 8-3/4"
- 1/2" NPT female thread inlet or 1/2" NPT male thread shank assembly
- Slip wall flanges

### 2.2 GPM Aerated Outlet

Handle	With Shanks	Compression Cartridge	Ceramic Cartridge	Control-A-Flow Cartridge
Metal Cross	–	LWM4-A21-A	LWM4-B21-A	LWM4-C21-A
	•	<b>LWM5-A21-A</b>	LWM5-B21-A	LWM5-C21-A
Plastic Cross	–	LWM4-A22-A	LWM4-B22-A	LWM4-C22-A
	•	LWM5-A22-A	LWM5-B22-A	LWM5-C22-A
Metal Wristblade	–	LWM4-A23-A	LWM4-B23-A	LWM4-C23-A
	•	LWM5-A23-A	LWM5-B23-A	LWM5-C23-A

### Straight Nozzle

Handle	With Shanks	Compression Cartridge	Ceramic Cartridge	Control-A-Flow Cartridge
Metal Cross	–	LWM4-A11-A	LWM4-B11-A	LWM4-C11-A
	•	LWM5-A11-A	LWM5-B11-A	LWM5-C11-A
Plastic Cross	–	LWM4-A12-A	LWM4-B12-A	LWM4-C12-A
	•	LWM5-A12-A	LWM5-B12-A	LWM5-C12-A
Metal Wristblade	–	LWM4-A13-A	LWM4-B13-A	LWM4-C13-A
	•	LWM5-A13-A	LWM5-B13-A	LWM5-C13-A

### Straight Nozzle With Aspirator

Handle	With Shanks	Compression Cartridge	Ceramic Cartridge	Control-A-Flow Cartridge
Metal Cross	–	LWM4-A31-A	LWM4-B31-A	LWM4-C31-A
	•	LWM5-A31-A	LWM5-B31-A	LWM5-C31-A
Plastic Cross	–	LWM4-A32-A	LWM4-B32-A	LWM4-C32-A
	•	LWM5-A32-A	LWM5-B32-A	LWM5-C32-A
Metal Wristblade	–	LWM4-A33-A	LWM4-B33-A	LWM4-C33-A
	•	LWM5-A33-A	LWM5-B33-A	LWM5-C33-A

## Wall Mounted with Adjustable Arms, 8" Gooseneck Spout



- Solid brass construction, polished chrome plated finish
- 8" Body, adjustable arms 7-1/4" - 8-3/4"
- 1/2" NPT female thread inlet or 1/2" NPT male thread shank assembly
- Slip wall flanges

### 2.2 GPM Aerated Outlet

Handle	With Shanks	Compression Cartridge	Ceramic Cartridge	Control-A-Flow Cartridge
Metal Cross	–	LWM4-A21-B	LWM4-B21-B	LWM4-C21-B
	•	LWM5-A21-B	LWM5-B21-B	LWM5-C21-B
Plastic Cross	–	LWM4-A22-B	LWM4-B22-B	LWM4-C22-B
	•	LWM5-A22-B	LWM5-B22-B	LWM5-C22-B
Metal Wristblade	–	LWM4-A23-B	LWM4-B23-B	LWM4-C23-B
	•	LWM5-A23-B	LWM5-B23-B	LWM5-C23-B

### Straight Nozzle

Handle	With Shanks	Compression Cartridge	Ceramic Cartridge	Control-A-Flow Cartridge
Metal Cross	–	<b>LWM4-A11-B</b>	LWM4-B11-B	LWM4-C11-B
	•	LWM5-A11-B	LWM5-B11-B	LWM5-C11-B
Plastic Cross	–	LWM4-A12-B	LWM4-B12-B	LWM4-C12-B
	•	LWM5-A12-B	LWM5-B12-B	LWM5-C12-B
Metal Wristblade	–	LWM4-A13-B	LWM4-B13-B	LWM4-C13-B
	•	LWM5-A13-B	LWM5-B13-B	LWM5-C13-B

### Straight Nozzle With Aspirator

Handle	With Shanks	Compression Cartridge	Ceramic Cartridge	Control-A-Flow Cartridge
Metal Cross	–	LWM4-A31-B	LWM4-B31-B	LWM4-C31-B
	•	LWM5-A31-B	LWM5-B31-B	LWM5-C31-B
Plastic Cross	–	LWM4-A32-B	LWM4-B32-B	LWM4-C32-B
	•	LWM5-A32-B	LWM5-B32-B	LWM5-C32-B
Metal Wristblade	–	LWM4-A33-B	LWM4-B33-B	LWM4-C33-B
	•	LWM5-A33-B	LWM5-B33-B	LWM5-C33-B

## Wall Mounted with Adjustable Arms, 5-1/4" Gooseneck Spout with Vacuum Breaker



- Solid brass construction, polished chrome plated finish
- 8" Body, adjustable arms 7-1/4" - 8-3/4"
- 1/2" NPT female thread inlet or 1/2" NPT male thread shank assembly
- Slip wall flanges

### 2.2 GPM Aerated Outlet

Handle	With Shanks	Compression Cartridge	Ceramic Cartridge	Control-A-Flow Cartridge
Metal Cross	–	LWM4-A21-E	LWM4-B21-E	LWM4-C21-E
	•	LWM5-A21-E	LWM5-B21-E	LWM5-C21-E
Plastic Cross	–	LWM4-A22-E	LWM4-B22-E	LWM4-C22-E
	•	LWM5-A22-E	LWM5-B22-E	LWM5-C22-E
Metal Wristblade	–	LWM4-A23-E	LWM4-B23-E	LWM4-C23-E
	•	<b>LWM5-A23-E</b>	LWM5-B23-E	LWM5-C23-E

### Straight Nozzle

Handle	With Shanks	Compression Cartridge	Ceramic Cartridge	Control-A-Flow Cartridge
Metal Cross	–	LWM4-A11-E	LWM4-B11-E	LWM4-C11-E
	•	LWM5-A11-E	LWM5-B11-E	LWM5-C11-E
Plastic Cross	–	LWM4-A12-E	LWM4-B12-E	LWM4-C12-E
	•	LWM5-A12-E	LWM5-B12-E	LWM5-C12-E
Metal Wristblade	–	LWM4-A13-E	LWM4-B13-E	LWM4-C13-E
	•	LWM5-A13-E	LWM5-B13-E	LWM5-C13-E

### Straight Nozzle With Aspirator

Handle	With Shanks	Compression Cartridge	Ceramic Cartridge	Control-A-Flow Cartridge
Metal Cross	–	LWM4-A31-E	LWM4-B31-E	LWM4-C31-E
	•	LWM5-A31-E	LWM5-B31-E	LWM5-C31-E
Plastic Cross	–	LWM4-A32-E	LWM4-B32-E	LWM4-C32-E
	•	LWM5-A32-E	LWM5-B32-E	LWM5-C32-E
Metal Wristblade	–	LWM4-A33-E	LWM4-B33-E	LWM4-C33-E
	•	LWM5-A33-E	LWM5-B33-E	LWM5-C33-E

## Wall Mounted with Adjustable Arms, 8" Gooseneck Spout with Vacuum Breaker



- Solid brass construction, polished chrome plated finish
- 8" Body, adjustable arms 7-1/4" - 8-3/4"
- 1/2" NPT female thread inlet or 1/2" NPT male thread shank assembly
- Slip wall flanges

### 2.2 GPM Aerated Outlet

Handle	With Shanks	Compression Cartridge	Ceramic Cartridge	Control-A-Flow Cartridge
Metal Cross	–	LWM4-A21-F	LWM4-B21-F	LWM4-C21-F
	•	LWM5-A21-F	LWM5-B21-F	LWM5-C21-F
Plastic Cross	–	LWM4-A22-F	LWM4-B22-F	LWM4-C22-F
	•	LWM5-A22-F	LWM5-B22-F	LWM5-C22-F
Metal Wristblade	–	LWM4-A23-F	LWM4-B23-F	LWM4-C23-F
	•	LWM5-A23-F	LWM5-B23-F	LWM5-C23-F

### Straight Nozzle

Handle	With Shanks	Compression Cartridge	Ceramic Cartridge	Control-A-Flow Cartridge
Metal Cross	–	LWM4-A11-F	LWM4-B11-F	LWM4-C11-F
	•	LWM5-A11-F	LWM5-B11-F	LWM5-C11-F
Plastic Cross	–	LWM4-A12-F	LWM4-B12-F	LWM4-C12-F
	•	<b>LWM5-A12-F</b>	LWM5-B12-F	LWM5-C12-F
Metal Wristblade	–	LWM4-A13-F	LWM4-B13-F	LWM4-C13-F
	•	LWM5-A13-F	LWM5-B13-F	LWM5-C13-F

### Straight Nozzle With Aspirator

Handle	With Shanks	Compression Cartridge	Ceramic Cartridge	Control-A-Flow Cartridge
Metal Cross	–	LWM4-A31-F	LWM4-B31-F	LWM4-C31-F
	•	LWM5-A31-F	LWM5-B31-F	LWM5-C31-F
Plastic Cross	–	LWM4-A32-F	LWM4-B32-F	LWM4-C32-F
	•	LWM5-A32-F	LWM5-B32-F	LWM5-C32-F
Metal Wristblade	–	LWM4-A33-F	LWM4-B33-F	LWM4-C33-F
	•	LWM5-A33-F	LWM5-B33-F	LWM5-C33-F

### Wall Mounted with Adjustable Arms, 5-1/4" Rigid Gooseneck Spout with Vacuum Breaker



- Solid brass construction, polished chrome plated finish
- 8" Body, adjustable arms 7-1/4" - 8-3/4"
- 1/2" NPT female thread inlet or 1/2" NPT male thread shank assembly
- Slip wall flanges

#### 2.2 GPM Aerated Outlet

Handle	With Shanks	Compression Cartridge	Ceramic Cartridge	Control-A-Flow Cartridge
Metal Cross	-	LWM4-A21-G	LWM4-B21-G	LWM4-C21-G
	•	LWM5-A21-G	LWM5-B21-G	LWM5-C21-G
Plastic Cross	-	LWM4-A22-G	LWM4-B22-G	LWM4-C22-G
	•	LWM5-A22-G	LWM5-B22-G	LWM5-C22-G
Metal Wristblade	-	<b>LWM4-A23-G</b>	LWM4-B23-G	LWM4-C23-G
	•	LWM5-A23-G	LWM5-B23-G	LWM5-C23-G

#### Straight Nozzle

Handle	With Shanks	Compression Cartridge	Ceramic Cartridge	Control-A-Flow Cartridge
Metal Cross	-	LWM4-A11-G	LWM4-B11-G	LWM4-C11-G
	•	LWM5-A11-G	LWM5-B11-G	LWM5-C11-G
Plastic Cross	-	LWM4-A12-G	LWM4-B12-G	LWM4-C12-G
	•	LWM5-A12-G	LWM5-B12-G	LWM5-C12-G
Metal Wristblade	-	LWM4-A13-G	LWM4-B13-G	LWM4-C13-G
	•	LWM5-A13-G	LWM5-B13-G	LWM5-C13-G

#### Straight Nozzle With Aspirator

Handle	With Shanks	Compression Cartridge	Ceramic Cartridge	Control-A-Flow Cartridge
Metal Cross	-	LWM4-A31-G	LWM4-B31-G	LWM4-C31-G
	•	LWM5-A31-G	LWM5-B31-G	LWM5-C31-G
Plastic Cross	-	LWM4-A32-G	LWM4-B32-G	LWM4-C32-G
	•	LWM5-A32-G	LWM5-B32-G	LWM5-C32-G
Metal Wristblade	-	LWM4-A33-G	LWM4-B33-G	LWM4-C33-G
	•	LWM5-A33-G	LWM5-B33-G	LWM5-C33-G

### Wall Mounted with Adjustable Arms, 8" Rigid Gooseneck Spout with Vacuum Breaker



- Solid brass construction, polished chrome plated finish
- 8" Body, adjustable arms 7-1/4" - 8-3/4"
- 1/2" NPT female thread inlet or 1/2" NPT male thread shank assembly
- Slip wall flanges

#### 2.2 GPM Aerated Outlet

Handle	With Shanks	Compression Cartridge	Ceramic Cartridge	Control-A-Flow Cartridge
Metal Cross	-	LWM4-A21-H	LWM4-B21-H	LWM4-C21-H
	•	LWM5-A21-H	LWM5-B21-H	LWM5-C21-H
Plastic Cross	-	LWM4-A22-H	LWM4-B22-H	LWM4-C22-H
	•	LWM5-A22-H	LWM5-B22-H	LWM5-C22-H
Metal Wristblade	-	LWM4-A23-H	LWM4-B23-H	LWM4-C23-H
	•	LWM5-A23-H	LWM5-B23-H	LWM5-C23-H

#### Straight Nozzle

Handle	With Shanks	Compression Cartridge	Ceramic Cartridge	Control-A-Flow Cartridge
Metal Cross	-	LWM4-A11-H	LWM4-B11-H	LWM4-C11-H
	•	LWM5-A11-H	LWM5-B11-H	LWM5-C11-H
Plastic Cross	-	LWM4-A12-H	LWM4-B12-H	LWM4-C12-H
	•	LWM5-A12-H	LWM5-B12-H	LWM5-C12-H
Metal Wristblade	-	LWM4-A13-H	LWM4-B13-H	LWM4-C13-H
	•	LWM5-A13-H	LWM5-B13-H	LWM5-C13-H

#### Straight Nozzle With Aspirator

Handle	With Shanks	Compression Cartridge	Ceramic Cartridge	Control-A-Flow Cartridge
Metal Cross	-	<b>LWM4-A31-H</b>	LWM4-B31-H	LWM4-C31-H
	•	LWM5-A31-H	LWM5-B31-H	LWM5-C31-H
Plastic Cross	-	LWM4-A32-H	LWM4-B32-H	LWM4-C32-H
	•	LWM5-A32-H	LWM5-B32-H	LWM5-C32-H
Metal Wristblade	-	LWM4-A33-H	LWM4-B33-H	LWM4-C33-H
	•	LWM5-A33-H	LWM5-B33-H	LWM5-C33-H

## Wall Mounted, 5-1/4" Gooseneck Spout



- Solid brass construction, polished chrome plated finish
- 3" vertical centers
- Straight inlet arm with 1/2" NPT female thread inlet or 1/2" NPT male thread shank assembly
- Integral wall flanges

### 2.2 GPM Aerated Outlet

Handle	With Shanks	Compression Cartridge	Ceramic Cartridge	Control-A-Flow Cartridge
Metal Cross	–	LWM6-A21-A	LWM6-B21-A	LWM6-C21-A
	•	LWM7-A21-A	LWM7-B21-A	LWM7-C21-A
Plastic Cross	–	LWM6-A22-A	LWM6-B22-A	LWM6-C22-A
	•	LWM7-A22-A	LWM7-B22-A	LWM7-C22-A
Metal Wristblade	–	LWM6-A23-A	LWM6-B23-A	LWM6-C23-A
	•	LWM7-A23-A	LWM7-B23-A	LWM7-C23-A

### Straight Nozzle

Handle	With Shanks	Compression Cartridge	Ceramic Cartridge	Control-A-Flow Cartridge
Metal Cross	–	LWM6-A11-A	LWM6-B11-A	LWM6-C11-A
	•	LWM7-A11-A	LWM7-B11-A	LWM7-C11-A
Plastic Cross	–	LWM6-A12-A	LWM6-B12-A	LWM6-C12-A
	•	LWM7-A12-A	LWM7-B12-A	LWM7-C12-A
Metal Wristblade	–	LWM6-A13-A	LWM6-B13-A	LWM6-C13-A
	•	LWM7-A13-A	LWM7-B13-A	<b>LWM7-C13-A</b>

### Straight Nozzle With Aspirator

Handle	With Shanks	Compression Cartridge	Ceramic Cartridge	Control-A-Flow Cartridge
Metal Cross	–	LWM6-A31-A	LWM6-B31-A	LWM6-C31-A
	•	LWM7-A31-A	LWM7-B31-A	LWM7-C31-A
Plastic Cross	–	LWM6-A32-A	LWM6-B32-A	LWM6-C32-A
	•	LWM7-A32-A	LWM7-B32-A	LWM7-C32-A
Metal Wristblade	–	LWM6-A33-A	LWM6-B33-A	LWM6-C33-A
	•	LWM7-A33-A	LWM7-B33-A	LWM7-C33-A

## Wall Mounted, 8" Gooseneck Spout



- Solid brass construction, polished chrome plated finish
- 3" vertical centers
- Straight inlet arm with 1/2" NPT female thread inlet or 1/2" NPT male thread shank assembly
- Integral wall flanges

### 2.2 GPM Aerated Outlet

Handle	With Shanks	Compression Cartridge	Ceramic Cartridge	Control-A-Flow Cartridge
Metal Cross	–	LWM6-A21-B	LWM6-B21-B	LWM6-C21-B
	•	LWM7-A21-B	LWM7-B21-B	LWM7-C21-B
Plastic Cross	–	LWM6-A22-B	LWM6-B22-B	LWM6-C22-B
	•	LWM7-A22-B	LWM7-B22-B	LWM7-C22-B
Metal Wristblade	–	LWM6-A23-B	<b>LWM6-B23-B</b>	LWM6-C23-B
	•	LWM7-A23-B	LWM7-B23-B	LWM7-C23-B

### Straight Nozzle

Handle	With Shanks	Compression Cartridge	Ceramic Cartridge	Control-A-Flow Cartridge
Metal Cross	–	LWM6-A11-B	LWM6-B11-B	LWM6-C11-B
	•	LWM7-A11-B	LWM7-B11-B	LWM7-C11-B
Plastic Cross	–	LWM6-A12-B	LWM6-B12-B	LWM6-C12-B
	•	LWM7-A12-B	LWM7-B12-B	LWM7-C12-B
Metal Wristblade	–	LWM6-A13-B	LWM6-B13-B	LWM6-C13-B
	•	LWM7-A13-B	LWM7-B13-B	LWM7-C13-B

### Straight Nozzle With Aspirator

Handle	With Shanks	Compression Cartridge	Ceramic Cartridge	Control-A-Flow Cartridge
Metal Cross	–	LWM6-A31-B	LWM6-B31-B	LWM6-C31-B
	•	LWM7-A31-B	LWM7-B31-B	LWM7-C31-B
Plastic Cross	–	LWM6-A32-B	LWM6-B32-B	LWM6-C32-B
	•	LWM7-A32-B	LWM7-B32-B	LWM7-C32-B
Metal Wristblade	–	LWM6-A33-B	LWM6-B33-B	LWM6-C33-B
	•	LWM7-A33-B	LWM7-B33-B	LWM7-C33-B

## Wall Mounted, 5-1/4" Gooseneck Spout with Vacuum Breaker



- Solid brass construction, polished chrome plated finish
- 3" vertical centers
- Straight inlet arm with 1/2" NPT female thread inlet or 1/2" NPT male thread shank assembly
- Integral wall flanges

### 2.2 GPM Aerated Outlet

Handle	With Shanks	Compression Cartridge	Ceramic Cartridge	Control-A-Flow Cartridge
Metal Cross	–	LWM6-A21-E	LWM6-B21-E	LWM6-C21-E
	•	<b>LWM7-A21-E</b>	LWM7-B21-E	LWM7-C21-E
Plastic Cross	–	LWM6-A22-E	LWM6-B22-E	LWM6-C22-E
	•	LWM7-A22-E	LWM7-B22-E	LWM7-C22-E
Metal Wristblade	–	LWM6-A23-E	LWM6-B23-E	LWM6-C23-E
	•	LWM7-A23-E	LWM7-B23-E	LWM7-C23-E

### Straight Nozzle

Handle	With Shanks	Compression Cartridge	Ceramic Cartridge	Control-A-Flow Cartridge
Metal Cross	–	LWM6-A11-E	LWM6-B11-E	LWM6-C11-E
	•	LWM7-A11-E	LWM7-B11-E	LWM7-C11-E
Plastic Cross	–	LWM6-A12-E	LWM6-B12-E	LWM6-C12-E
	•	LWM7-A12-E	LWM7-B12-E	LWM7-C12-E
Metal Wristblade	–	LWM6-A13-E	LWM6-B13-E	LWM6-C13-E
	•	LWM7-A13-E	LWM7-B13-E	LWM7-C13-E

### Straight Nozzle With Aspirator

Handle	With Shanks	Compression Cartridge	Ceramic Cartridge	Control-A-Flow Cartridge
Metal Cross	–	LWM6-A31-E	LWM6-B31-E	LWM6-C31-E
	•	LWM7-A31-E	LWM7-B31-E	LWM7-C31-E
Plastic Cross	–	LWM6-A32-E	LWM6-B32-E	LWM6-C32-E
	•	LWM7-A32-E	LWM7-B32-E	LWM7-C32-E
Metal Wristblade	–	LWM6-A33-E	LWM6-B33-E	LWM6-C33-E
	•	LWM7-A33-E	LWM7-B33-E	LWM7-C33-E

## Wall Mounted, 8" Gooseneck Spout with Vacuum Breaker



- Solid brass construction, polished chrome plated finish
- 3" vertical centers
- Straight inlet arm with 1/2" NPT female thread inlet or 1/2" NPT male thread shank assembly
- Integral wall flanges

### 2.2 GPM Aerated Outlet

Handle	With Shanks	Compression Cartridge	Ceramic Cartridge	Control-A-Flow Cartridge
Metal Cross	–	LWM6-A21-F	LWM6-B21-F	LWM6-C21-F
	•	LWM7-A21-F	LWM7-B21-F	LWM7-C21-F
Plastic Cross	–	LWM6-A22-F	LWM6-B22-F	LWM6-C22-F
	•	LWM7-A22-F	LWM7-B22-F	LWM7-C22-F
Metal Wristblade	–	LWM6-A23-F	LWM6-B23-F	LWM6-C23-F
	•	LWM7-A23-F	LWM7-B23-F	LWM7-C23-F

### Straight Nozzle

Handle	With Shanks	Compression Cartridge	Ceramic Cartridge	Control-A-Flow Cartridge
Metal Cross	–	LWM6-A11-F	LWM6-B11-F	LWM6-C11-F
	•	<b>LWM7-A11-F</b>	LWM7-B11-F	LWM7-C11-F
Plastic Cross	–	LWM6-A12-F	LWM6-B12-F	LWM6-C12-F
	•	LWM7-A12-F	LWM7-B12-F	LWM7-C12-F
Metal Wristblade	–	LWM6-A13-F	LWM6-B13-F	LWM6-C13-F
	•	LWM7-A13-F	LWM7-B13-F	LWM7-C13-F

### Straight Nozzle With Aspirator

Handle	With Shanks	Compression Cartridge	Ceramic Cartridge	Control-A-Flow Cartridge
Metal Cross	–	LWM6-A31-F	LWM6-B31-F	LWM6-C31-F
	•	LWM7-A31-F	LWM7-B31-F	LWM7-C31-F
Plastic Cross	–	LWM6-A32-F	LWM6-B32-F	LWM6-C32-F
	•	LWM7-A32-F	LWM7-B32-F	LWM7-C32-F
Metal Wristblade	–	LWM6-A33-F	LWM6-B33-F	LWM6-C33-F
	•	LWM7-A33-F	LWM7-B33-F	LWM7-C33-F



## Wall Mounted, 5-1/4" Rigid Gooseneck Spout with Vacuum Breaker



- Solid brass construction, polished chrome plated finish
- 3" vertical centers
- Straight inlet arm with 1/2" NPT female thread inlet or 1/2" NPT male thread shank assembly
- Integral wall flanges

### Straight Nozzle

Handle	With Shanks	Compression Cartridge	Ceramic Cartridge	Control-A-Flow Cartridge
Metal Cross	–	LWM6-A11-G	LWM6-B11-G	LWM6-C11-G
	•	LWM7-A11-G	<b>LWM7-B11-G</b>	LWM7-C11-G
Plastic Cross	–	LWM6-A12-G	LWM6-B12-G	LWM6-C12-G
	•	LWM7-A12-G	LWM7-B12-G	LWM7-C12-G
Metal Wristblade	–	LWM6-A13-G	LWM6-B13-G	LWM6-C13-G
	•	LWM7-A13-G	LWM7-B13-G	LWM7-C13-G

### 2.2 GPM Aerated Outlet

Handle	With Shanks	Compression Cartridge	Ceramic Cartridge	Control-A-Flow Cartridge
Metal Cross	–	LWM6-A21-G	LWM6-B21-G	LWM6-C21-G
	•	LWM7-A21-G	LWM7-B21-G	LWM7-C21-G
Plastic Cross	–	LWM6-A22-G	LWM6-B22-G	LWM6-C22-G
	•	LWM7-A22-G	LWM7-B22-G	LWM7-C22-G
Metal Wristblade	–	LWM6-A23-G	LWM6-B23-G	LWM6-C23-G
	•	LWM7-A23-G	LWM7-B23-G	LWM7-C23-G

### Straight Nozzle With Aspirator

Handle	With Shanks	Compression Cartridge	Ceramic Cartridge	Control-A-Flow Cartridge
Metal Cross	–	LWM6-A31-G	LWM6-B31-G	LWM6-C31-G
	•	LWM7-A31-G	LWM7-B31-G	LWM7-C31-G
Plastic Cross	–	LWM6-A32-G	LWM6-B32-G	LWM6-C32-G
	•	LWM7-A32-G	LWM7-B32-G	LWM7-C32-G
Metal Wristblade	–	LWM6-A33-G	LWM6-B33-G	LWM6-C33-G
	•	LWM7-A33-G	LWM7-B33-G	LWM7-C33-G

## Wall Mounted, 8" Rigid Gooseneck Spout with Vacuum Breaker



- Solid brass construction, polished chrome plated finish
- 3" vertical centers
- Straight inlet arm with 1/2" NPT female thread inlet or 1/2" NPT male thread shank assembly
- Integral wall flanges

### Straight Nozzle

Handle	With Shanks	Compression Cartridge	Ceramic Cartridge	Control-A-Flow Cartridge
Metal Cross	–	LWM6-A11-H	LWM6-B11-H	LWM6-C11-H
	•	LWM7-A11-H	LWM7-B11-H	LWM7-C11-H
Plastic Cross	–	LWM6-A12-H	LWM6-B12-H	LWM6-C12-H
	•	LWM7-A12-H	LWM7-B12-H	LWM7-C12-H
Metal Wristblade	–	LWM6-A13-H	LWM6-B13-H	LWM6-C13-H
	•	LWM7-A13-H	LWM7-B13-H	LWM7-C13-H

### 2.2 GPM Aerated Outlet

Handle	With Shanks	Compression Cartridge	Ceramic Cartridge	Control-A-Flow Cartridge
Metal Cross	–	LWM6-A21-H	LWM6-B21-H	LWM6-C21-H
	•	LWM7-A21-H	LWM7-B21-H	LWM7-C21-H
Plastic Cross	–	<b>LWM6-A22-H</b>	LWM6-B22-H	LWM6-C22-H
	•	LWM7-A22-H	LWM7-B22-H	LWM7-C22-H
Metal Wristblade	–	LWM6-A23-H	LWM6-B23-H	LWM6-C23-H
	•	LWM7-A23-H	LWM7-B23-H	LWM7-C23-H

### Straight Nozzle With Aspirator

Handle	With Shanks	Compression Cartridge	Ceramic Cartridge	Control-A-Flow Cartridge
Metal Cross	–	LWM6-A31-H	LWM6-B31-H	LWM6-C31-H
	•	LWM7-A31-H	LWM7-B31-H	LWM7-C31-H
Plastic Cross	–	LWM6-A32-H	LWM6-B32-H	LWM6-C32-H
	•	LWM7-A32-H	LWM7-B32-H	LWM7-C32-H
Metal Wristblade	–	LWM6-A33-H	LWM6-B33-H	LWM6-C33-H
	•	LWM7-A33-H	LWM7-B33-H	LWM7-C33-H

### Deck Mounted, Single Hole Manual Faucet

- Hot and cold water mixing faucet
- 2.2 GPM (8.3 L/min) aerator
- 2-3/8" Vandal proof lever handle
- Polished chrome plated finish
- Quatern compression operating cartridge
- 3/8" Compression flexible stainless steel supply hoses



Spout	Model
6" S Type Swing	<b>51-ABCP</b>
8" L Type Swing	51-L8ABCP
12" L Type Swing	51-L12ABCP

### Deck Mounted, 4" Fixed Centers, Manual Faucet

- Hot and cold water mixing faucet
- 2.2 GPM (8.3 L/min) aerator
- Quatern compression operating cartridge
- 1/2" NPSM supply inlets and coupling nut for 3/8" or 1/2" flexible riser
- Polished chrome plated finish
- Gooseneck spouts include rigid/swing option



Spout	Handle	Model
3-1/2" Gooseneck	Wristblade	895-317ABCP
5-1/4" Gooseneck		<b>895-317GN2AE3ABCP</b>
8" Gooseneck w/ Vacuum Breaker		895-317GN8BVBE2-2*
8" Gooseneck w/ Vacuum Breaker		895-317GN8BVBE3MAB
8" Gooseneck	Lever	895-GN8AE3ABCP

\*Full-flow 3/4" male hose thread outlet

### Deck Mounted, 8" Fixed Centers, Manual Faucet

- Concealed, hot and cold water faucet
- 2.2 GPM (8.3 L/min) aerator
- Quatern compression operating cartridge
- 1/2" NPSM supply inlets and coupling nut for 3/8" or 1/2" flexible riser
- Polished chrome plated finish
- Gooseneck spouts include rigid/swing option



Spout	Handle	Model
9-1/2" L Type Swing	Wristblade	201-A317ABCP
8" Gooseneck w/ Vacuum Breaker		201-AG8BVBE3M317AB
5-1/4" Gooseneck		786-E3ABCP
6" Gooseneck w/ Vacuum Breaker		<b>786-GN2BVBE3-2ABCP</b>
8" Gooseneck		786-GN8AE3ABCP
9-1/2" L Type Swing	Lever	201-AABCP
9-1/2" L Type Swing	Canopy	201-A1000ABCP

## Wall Mounted, Manual Faucet

- 8" Body, adjustable arms 7-1/4" - 8-3/4"
- Concealed, hot and cold water faucet
- 2.2 GPM (8.3 L/min) aerator
- Quatern compression operating cartridge
- 1/2" NPSM supply inlets and coupling nut for 3/8" or 1/2" flexible riser
- Polished chrome plated finish
- Gooseneck spouts include rigid/swing option



Spout	Handle	Model
3-1/2" Gooseneck	Wristblade	<b>631-ABCP</b>
5-1/4" Gooseneck		631-GN2AE3ABCP
8" Gooseneck		631-GN8AE3ABCP
6" S Type Swing	Lever	540-LDABCP
8" L Type Swing		540-LDL8ABCP
9-1/2" L Type Swing		540-LDL9ABCP
12" L Type Swing		540-LDL12ABCP
15" L Type Swing		540-LDL15ABCP

## Wall Mounted, Service Sink Faucet

- 8" Body, adjustable arms 7-1/4" - 8-3/4"
- Vacuum breaker spout with pail hook and 3/4" male hose thread outlet
- 2-3/8" Vandal proof lever handle
- Polished chrome



Finish	Model
Polished Chrome	<b>540-LD897SCP</b>

## Wall Mounted, Service Sink Faucet

- 8" Body, adjustable arms 7-5/8" - 8-3/8"
- Integral stop valves for servicing the product
- Vacuum breaker spout with pail hook and 3/4" male hose thread outlet
- 2-3/8" Vandal proof lever handle



Finish	Check Valves	Model
Polished Chrome	Y	897-CCP
	-	897-CP
Rough Chrome	Y	897-CRCF
	-	<b>897-RCF</b>

### Wall Mounted, Sill Fitting

- Single hole
- 2-1/4" tee handle
- 3/4" male hose thread outlet
- 1/2" NPT female thread inlet
- Slip wall flange



Finish	Cartridge	In-Line Vacuum Breaker	Model
Polished Chrome	Self-closing	–	293-244CP
	Quatum® Compression	–	293-369COLDCP
	Slow Compression	–	<b>293-CP</b>
	Slow Compression	•	293-E27CP
Rough Chrome	Self-closing	–	293-244RCF
	Slow Compression	–	293-RCF
	Ceramic	–	293-XKRCF

### Wall Mounted, Inside Sill Fitting

- Atmospheric vacuum breaker
- Polished chrome finish
- 3/4" male hose thread outlet
- Integral wall flange



Inlet	Cartridge	Handle	Model
1/2" NPT Female Thread	Slow Compression	Tee	952-12CP
	Ceramic	Tee	952-12XKCP
3/4" NPT Female Thread	Slow Compression	Lever	952-269CP
	Slow Compression	Cross	952-633PLCP
	Slow Compression	Tee	<b>952-CP</b>
	Ceramic	Tee	952-XKCP

### Straight Stops

- 1/2" NPT female inlet
- 1/2" NPT female outlet
- Polished chrome finish



Handle	Cartridge	Integral Check	Model
Cross	Slow Compression	–	<b>45-ABCP</b>
	Ceramic	–	45-XKABCP
Tee	Slow Compression	–	<b>45-LKABCP</b>
	Slow Compression	•	45-LKCABCP

## Angle Stops

- 1/2" NPT female inlet
- 1/2" NPT female outlet
- Slow compression cartridge
- Polished chrome finish



Handle	Integral Check	Model
Cross	–	442-ABCP
Tee	–	<b>442-LKABCP</b>
	•	442-LKCABCP

## Compression Angle Stops

- Loose key handle
- Choice of 1/2" or 3/8" inlets and outlets
- Polished chrome finish



Outlet	1/2" NPT Female Thread Inlet	3/8" NPT Female Thread Inlet
1/2" O.D. Female Compression	<b>STC-22-00-AB</b>	STC-12-00-AB
3/8" O.D. Female Compression	STC-21-00-AB	STC-11-00-AB

## Compression Angle Stops with Riser

- Loose key handle
- Choice of 1/2" or 3/8" inlets and outlets
- Polished chrome finish



### 12" Riser

Outlet	1/2" NPT Female Thread Inlet	3/8" NPT Female Thread Inlet
1/2" O.D. Female Compression	<b>STC-22-11-AB</b>	STC-12-11-AB
3/8" O.D. Female Compression	STC-21-11-AB	STC-11-11-AB

### 20" Riser

Outlet	1/2" NPT Female Thread Inlet	3/8" NPT Female Thread Inlet
1/2" O.D. Female Compression	STC-22-12-AB	STC-12-12-AB
3/8" O.D. Female Compression	STC-21-12-AB	STC-11-12-AB

### Dual Supply Pedal Valve With Long Pedals

- Long pedal valves
- Solid brass construction
- Choice of polished chrome or rough chrome finish
- Choice of slow or fast closing metering cartridge
- Two 1/2" NPT female thread inlets
- 3/8" NPT female thread outlet



Finish	Slow Closing Cartridge	Fast Closing Cartridge
Polished Chrome	625-LPSLOABCP	<b>625-LPABCP</b>
Rough Chrome	625-LPSLOABRCF	625-LPABRCF

### Dual Supply Pedal Valve With Short Pedals

- Short pedal valves
- Solid brass construction
- Choice of polished chrome or rough chrome finish
- Choice of slow or fast closing metering cartridge
- Two 1/2" NPT female thread inlets
- 3/8" NPT female thread outlet



Finish	Slow Closing Cartridge	Fast Closing Cartridge
Polished Chrome	<b>625-SLOABCP</b>	625-ABCP
Rough Chrome	625-SLOABRCF	625-ABRCF

### Single Supply Pedal Valve With Short Pedal

- Short pedal valve
- Solid brass construction
- Choice of polished chrome or rough chrome finish
- Fast closing metering cartridge
- 1/2" NPT female thread inlet
- 3/8" NPT female thread outlet



Finish	Fast Closing Cartridge
Polished Chrome	<b>628-ABCP</b>
Rough Chrome	628-ABRCF

### Deck Mount Remote Spouts

- Gooseneck spouts include rigid/swing option
- 2.2 GPM aerator or serrated nozzle outlet
- 1/2" NPSM supply inlet with coupling nut for 3/8" or 1/2" flexible riser
- Chrome plated finish



Spout Dimensions	2.2 GPM Aerated	Full Flow Nozzle
5-1/4" Gooseneck	626-E3ABCP	626-GN2BE7CP
6" Gooseneck with Vacuum Breaker	626-GN2BVBE3-2AB	626-GN2BVBE7CP
6" S-Type Swing Spout	626-S6ABCP	-
8" Gooseneck	<b>626-GN8AE3ABCP</b>	626-GN8BE7CP
8" Gooseneck with Vacuum Breaker	626-GN8BVBE3-2AB	626-GN8BVBE7CP

### Wall Mount Remote Spouts

- Gooseneck spouts include rigid/swing option
- 2.2 GPM aerator or serrated nozzle outlet
- 1/2" NPT female thread inlet
- Chrome plated finish



Spout Dimensions	2.2 GPM Aerated	Full Flow Nozzle
3-1/2" Gooseneck	629-E3ABCP	-
5-1/4" Gooseneck	<b>629-GN2AE3ABCP</b>	629-GN2BE7CP
6" Gooseneck with Vacuum Breaker	629-GN2BVBE3-2AB	629-GN2BVBE7CP
6" S-Type Swing Spout	629-S6ABCP	-
8" Gooseneck	629-GN8AE3ABCP	629-GN8BE7CP
8" Gooseneck with Vacuum Breaker	629-GN8BVBE3-2AB	629-GN8BVBE7CP

NOTES

---

---

---

---

---

---

---

---

---

---

---

---

---

---

---

---

---

---

---

---

---

---

---

---

---

---

---

---

---

---

## Deck Mounted Electronic Faucet, Single Supply

- Single supply for tempered water
- Multiple field adjustable modes and ranges
- Compatible with Chicago Faucets Commander™ hand held programming unit
- 5-1/4" gooseneck spout with serrated nozzle
- Available with ASSE 1070 thermostatic mixing valve
- Choice of battery, hard wire, or plug-in power options



Power	Less Mixing Valve	With Mixing Valve
Battery	LEF-B11-00	LEF-B11-01
Plug-In Transformer	<b>LEF-A11-10</b>	LEF-A11-11
Hard Wire Transformer	LEF-A11-20	LEF-A11-21

## Deck Mounted Electronic Faucet, Dual Supply With Internal Mechanical Mixer

- Dual supply for hot and cold water service
- Multiple field adjustable modes and ranges
- Compatible with Chicago Faucets Commander™ hand held programming unit
- 5-1/4" gooseneck spout with serrated nozzle
- Available with ASSE 1070 thermostatic mixing valve with cold water bypass
- Choice of battery, hard wire, or plug-in power options



Power	Less Mixing Valve	With Mixing Valve
Battery	<b>LEF-B21-00</b>	LEF-B21-01
Plug-In Transformer	LEF-A21-10	LEF-A21-11
Hard Wire Transformer	LEF-A21-20	LEF-A21-21

## Deck Mounted Electronic Faucet, Dual Supply With User Temperature Control

- Dual supply for hot and cold water service
- Multiple field adjustable modes and ranges
- Compatible with Chicago Faucets Commander™ hand held programming unit
- 5-1/4" gooseneck spout with serrated nozzle
- Available with ASSE 1070 thermostatic mixing valve with cold water bypass
- Choice of battery, hard wire, or plug-in power options



Power	Less Mixing Valve	With Mixing Valve
Battery	LEF-B31-00	LEF-B31-01
Plug-In Transformer	LEF-A31-10	LEF-A31-11
Hard Wire Transformer	<b>LEF-A31-20</b>	LEF-A31-21



## Wall Mounted Electronic Faucet, Single Supply

- Single supply for tempered water
- Multiple field adjustable modes and ranges
- Compatible with Chicago Faucets Commander™ hand held programming unit
- 5-1/4" gooseneck spout with serrated nozzle
- Available with ASSE 1070 thermostatic mixing valve
- Choice of battery, hard wire, or plug-in power options



Power	Less Mixing Valve	With Mixing Valve
Battery	<b>LEF-B41-00</b>	LEF-B41-01
Plug-In Transformer	LEF-A41-10	LEF-A41-11
Hard Wire Transformer	LEF-A41-20	LEF-A41-21

## Wall Mounted Electronic Faucet, Dual Supply With Internal Mechanical Mixer

- Dual supply for hot and cold water service
- Multiple field adjustable modes and ranges
- Compatible with Chicago Faucets Commander™ hand held programming unit
- 5-1/4" gooseneck spout with serrated nozzle
- Available with ASSE 1070 thermostatic mixing valve with cold water bypass
- Choice of battery, hard wire, or plug-in power options



Power	Less Mixing Valve	With Mixing Valve
Battery	LEF-B51-00	LEF-B51-01
Plug-In Transformer	<b>LEF-A51-10</b>	LEF-A51-11
Hard Wire Transformer	LEF-A51-20	LEF-A51-21

## Wall Mounted Electronic Faucet, Dual Supply With User Temperature Control

- Dual supply for hot and cold water service
- Multiple field adjustable modes and ranges
- Compatible with Chicago Faucets Commander™ hand held programming unit
- 5-1/4" gooseneck spout with serrated nozzle
- Available with ASSE 1070 thermostatic mixing valve with cold water bypass
- Choice of battery, hard wire, or plug-in power options



Power	Less Mixing Valve	With Mixing Valve
Battery	LEF-B61-00	LEF-B61-01
Plug-In Transformer	LEF-A61-10	LEF-A61-11
Hard Wire Transformer	<b>LEF-A61-20</b>	LEF-A61-21

## Chicago Faucets Commander™ Hand Held Programming Unit

- Includes Commander software pre-installed, USB cable, two 'AA' batteries, Quick Start Guide
- Adjust timing, response, sensor range, select special operational modes, and collect usage data



Commander
116.585.00.1

## Deck Mounted Pre-Rinse Units



### 2305-VBABCP

- 90-L spray valve
- 23" riser and 44" flexible steel hose with insulated handle
- 3/8" compression stainless steel supply hoses
- With in-line back flow preventer



### 526-919SLABCP

- 90-L spray valve
- 23" riser and 44" flexible steel hose with insulated handle
- 1/2" NPSM supply inlets and coupling nut for 3/8" or 1/2" flexible risers



### 920-L204AB

- 90-L spray valve
- 23" riser and 44" flexible steel hose with insulated handle
- 3/8" compression stainless steel supply hoses



### 919-VBHS90ANGABCP

- 90-L spray valve
- 44" flexible hose with insulated handle
- 3/8" compression stainless steel supply hoses
- With in-line back flow preventer

### 920-LVB204AB

- With in-line back flow preventer



### 919-L204ABCP

- 90-L spray valve
- 23" riser and 44" flexible steel hose with insulated handle
- 3-1/2" inlet tee with 1/4" NPT check stop tailpieces



### 923-GCL204WSAB

- 90-L spray valve
- 23" riser and 44" flexible steel hose with insulated handle
- 1/2" NPT male inlet and outlet with locknut washers



### 919-L613AABCP

- 90-L spray valve
- 9-1/2" L type swing spout
- Full flow outlet
- 23" riser and 44" flexible steel hose with insulated handle
- 3-1/2" inlet tee with 1/4" NPT check stop tailpieces



### 613-AABCP

- 9-1/2" L type swing spout
- Full flow outlet
- 1-1/16" - 18 UNEF female thread inlet

### 919-LVB204ABCP

- With in-line back flow preventer

### 923-GCLVB204WSAB

- With in-line back flow preventer

## Wall Mounted Pre-Rinse Units



### 510-GC613AL12ABCP

- 90-L spray valve
- 12" L type swing spout
- Full flow outlet
- 23" riser and 44" flexible steel hose with insulated handle
- 3-3/8" body, adjustable arms 3" - 8-3/8"
- 2-5/16" diameter slip flange



### 923-LHC613AABCP

- 90-L spray valve
- 9-1/2" L type swing spout
- Full flow outlet
- 23" riser and 44" flexible steel hose with insulated handle
- 3-3/8" body, adjustable arms 3" - 8-3/8"
- 2-5/16" diameter slip flange



### 509-GCLABCP

- 90-ANG spray valve
- 9-1/2" L type swing spout
- Full flow outlet
- 60" flexible steel hose with insulated handle
- 8" body, adjustable arms 7-1/4" - 8-3/4"
- 3/8" offset inlet supply arm with integral check with 1/2" NPT female inlet



### 510-GCL204WSAB

- 90-L spray valve
- 23" riser and 44" flexible steel hose with insulated handle
- 3-3/8" body, adjustable arms 3" - 8-3/8"
- 1/2" NPT male inlet and outlet with locknut washers

### 510-GCLVB204WSAB

- With in-line back flow preventer

## Spray Valves



### 90-ANGABCP

- 1.0 GPM spray



### 90-ANGE3ABCP

- 2.2 GPM outlet



### 90-GNABCP

- Full flow gooseneck



### 90-HABCP

- 2.5 GPM spray



### 90-LABCP

- 1.0 GPM spray



### 99-ASAB

- 1.25 GPM adjustable spray pattern



### 99TFAB

- 0.91/0.99 GPM adjustable spray pattern

## How to build and order a Chicago Faucets laboratory gas needle valve fitting.

Chicago Faucets makes it easy for you to build gas needle valve fittings that meet your exact requirements. You can reference the charts on the following pages, or you can build your own valve by choosing the components below to configure your model number.

**LGN** **A** - **B** **C** **D** **E** - **F**  
 (Lab Gas Needle Valve)

### Valve Base

**A**



Straight Valve



Angle Valve

### Cartridge

**B**



Compression

### Outlet

**C**



Straight Nozzle



30° Nozzle

### EXAMPLE



### LGN1-A21A-25

Straight valves with 30° outlets, metal lever handles with AIR index buttons, and single hole turret.

### Handle

**D**



Metal

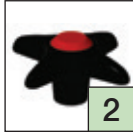

Plastic

### Button

**E**

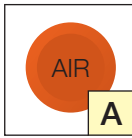

Air

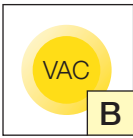

Vacuum

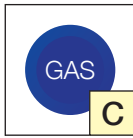

Gas

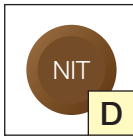

Nitrogen

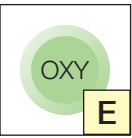

Oxygen

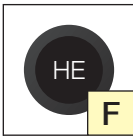

Helium

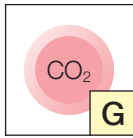

Carbon Dioxide

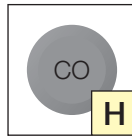

Carbon Monoxide

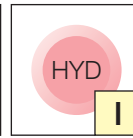

Hydrogen

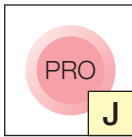

Propane

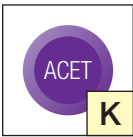

Acetylene

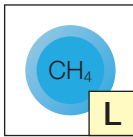

Methane

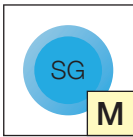

Specialty Gas

### Turret

**F**



Single



Dual 90°



Dual 180°



Three Hole



Four Hole



Single Wall Flange

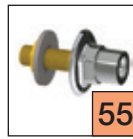

Single Wall Flange with Shank



Dual Wall Flange

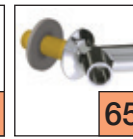

Dual Wall Flange with Shank

## Straight Pattern Gas Needle Valve

- Solid brass straight valve body
- Polished chrome plated finish
- 2-1/2" vandal proof cross handle
- 3/8" - 18 NPT male thread inlet



Index Button	Metal Handle		Plastic Handle	
	Straight Nozzle	30° Nozzle	Straight Nozzle	30° Nozzle
AIR	<b>LGN1-A11A</b>	LGN1-A21A	LGN1-A12A	LGN1-A22A
VAC	LGN1-A11B	LGN1-A21B	LGN1-A12B	LGN1-A22B
GAS	LGN1-A11C	LGN1-A21C	LGN1-A12C	LGN1-A22C
NIT	LGN1-A11D	LGN1-A21D	LGN1-A12D	LGN1-A22D
OXY	LGN1-A11E	LGN1-A21E	LGN1-A12E	LGN1-A22E
HE	LGN1-A11F	LGN1-A21F	LGN1-A12F	LGN1-A22F
CO2	LGN1-A11G	LGN1-A21G	LGN1-A12G	LGN1-A22G
CO	LGN1-A11H	LGN1-A21H	LGN1-A12H	LGN1-A22H
HYD	LGN1-A11I	LGN1-A21I	LGN1-A12I	LGN1-A22I
PRO	LGN1-A11J	LGN1-A21J	LGN1-A12J	LGN1-A22J
ACET	LGN1-A11K	LGN1-A21K	LGN1-A12K	LGN1-A22K
CH4	LGN1-A11L	LGN1-A21L	LGN1-A12L	LGN1-A22L
SG	LGN1-A11M	LGN1-A21M	LGN1-A12M	LGN1-A22M

## Deck Mounted, Straight Pattern Single Gas Needle Valve Assembly

- Solid brass turret with one outlet
- Solid brass straight valve body
- Polished chrome plated finish
- 2-1/2" vandal proof cross handle
- 3/8" - 18 NPT male thread shank assembly



Index Button	Metal Handle		Plastic Handle	
	Straight Nozzle	30° Nozzle	Straight Nozzle	30° Nozzle
AIR	LGN1-A11A-10	LGN1-A21A-10	LGN1-A12A-10	LGN1-A22A-10
VAC	LGN1-A11B-10	LGN1-A21B-10	LGN1-A12B-10	LGN1-A22B-10
GAS	LGN1-A11C-10	LGN1-A21C-10	LGN1-A12C-10	<b>LGN1-A22C-10</b>
NIT	LGN1-A11D-10	LGN1-A21D-10	LGN1-A12D-10	LGN1-A22D-10
OXY	LGN1-A11E-10	LGN1-A21E-10	LGN1-A12E-10	LGN1-A22E-10
HE	LGN1-A11F-10	LGN1-A21F-10	LGN1-A12F-10	LGN1-A22F-10
CO2	LGN1-A11G-10	LGN1-A21G-10	LGN1-A12G-10	LGN1-A22G-10
CO	LGN1-A11H-10	LGN1-A21H-10	LGN1-A12H-10	LGN1-A22H-10
HYD	LGN1-A11I-10	LGN1-A21I-10	LGN1-A12I-10	LGN1-A22I-10
PRO	LGN1-A11J-10	LGN1-A21J-10	LGN1-A12J-10	LGN1-A22J-10
ACET	LGN1-A11K-10	LGN1-A21K-10	LGN1-A12K-10	LGN1-A22K-10
CH4	LGN1-A11L-10	LGN1-A21L-10	LGN1-A12L-10	LGN1-A22L-10
SG	LGN1-A11M-10	LGN1-A21M-10	LGN1-A12M-10	LGN1-A22M-10

## Deck Mounted, Straight Pattern Dual 90° Gas Needle Valve Assembly

- Solid brass turret with two 90° outlets
- Solid brass straight valve body
- Polished chrome plated finish
- 2-1/2" vandal proof cross handle
- 3/8" - 18 NPT male thread shank assembly



Index Button	Metal Handle		Plastic Handle	
	Straight Nozzle	30° Nozzle	Straight Nozzle	30° Nozzle
AIR	LGN1-A11A-20	LGN1-A21A-20	LGN1-A12A-20	LGN1-A22A-20
VAC	LGN1-A11B-20	LGN1-A21B-20	LGN1-A12B-20	LGN1-A22B-20
GAS	LGN1-A11C-20	<b>LGN1-A21C-20</b>	LGN1-A12C-20	LGN1-A22C-20
NIT	LGN1-A11D-20	LGN1-A21D-20	LGN1-A12D-20	LGN1-A22D-20
OXY	LGN1-A11E-20	LGN1-A21E-20	LGN1-A12E-20	LGN1-A22E-20
HE	LGN1-A11F-20	LGN1-A21F-20	LGN1-A12F-20	LGN1-A22F-20
CO2	LGN1-A11G-20	LGN1-A21G-20	LGN1-A12G-20	LGN1-A22G-20
CO	LGN1-A11H-20	LGN1-A21H-20	LGN1-A12H-20	LGN1-A22H-20
HYD	LGN1-A11I-20	LGN1-A21I-20	LGN1-A12I-20	LGN1-A22I-20
PRO	LGN1-A11J-20	LGN1-A21J-20	LGN1-A12J-20	LGN1-A22J-20
ACET	LGN1-A11K-20	LGN1-A21K-20	LGN1-A12K-20	LGN1-A22K-20
CH4	LGN1-A11L-20	LGN1-A21L-20	LGN1-A12L-20	LGN1-A22L-20
SG	LGN1-A11M-20	LGN1-A21M-20	LGN1-A12M-20	LGN1-A22M-20

## Deck Mounted, Straight Pattern Dual 180° Gas Needle Valve Assembly

- Solid brass turret with two 180° outlets
- Solid brass straight valve body
- Polished chrome plated finish
- 2-1/2" vandal proof cross handle
- 3/8" - 18 NPT male thread shank assembly



Index Button	Metal Handle		Plastic Handle	
	Straight Nozzle	30° Nozzle	Straight Nozzle	30° Nozzle
AIR	LGN1-A11A-25	LGN1-A21A-25	LGN1-A12A-25	LGN1-A22A-25
VAC	LGN1-A11B-25	LGN1-A21B-25	<b>LGN1-A12B-25</b>	LGN1-A22B-25
GAS	LGN1-A11C-25	LGN1-A21C-25	LGN1-A12C-25	LGN1-A22C-25
NIT	LGN1-A11D-25	LGN1-A21D-25	LGN1-A12D-25	LGN1-A22D-25
OXY	LGN1-A11E-25	LGN1-A21E-25	LGN1-A12E-25	LGN1-A22E-25
HE	LGN1-A11F-25	LGN1-A21F-25	LGN1-A12F-25	LGN1-A22F-25
CO2	LGN1-A11G-25	LGN1-A21G-25	LGN1-A12G-25	LGN1-A22G-25
CO	LGN1-A11H-25	LGN1-A21H-25	LGN1-A12H-25	LGN1-A22H-25
HYD	LGN1-A11I-25	LGN1-A21I-25	LGN1-A12I-25	LGN1-A22I-25
PRO	LGN1-A11J-25	LGN1-A21J-25	LGN1-A12J-25	LGN1-A22J-25
ACET	LGN1-A11K-25	LGN1-A21K-25	LGN1-A12K-25	LGN1-A22K-25
CH4	LGN1-A11L-25	LGN1-A21L-25	LGN1-A12L-25	LGN1-A22L-25
SG	LGN1-A11M-25	LGN1-A21M-25	LGN1-A12M-25	LGN1-A22M-25

## Deck Mounted, Straight Pattern Three Gas Needle Valve Assembly

- Solid brass turret with three outlets
- Solid brass straight valve body
- Polished chrome plated finish
- 2-1/2" vandal proof cross handle
- 3/8" - 18 NPT male thread shank assembly



Index Button	Metal Handle		Plastic Handle	
	Straight Nozzle	30° Nozzle	Straight Nozzle	30° Nozzle
AIR	<b>LGN1-A11A-30</b>	LGN1-A21A-30	LGN1-A12A-30	LGN1-A22A-30
VAC	LGN1-A11B-30	LGN1-A21B-30	LGN1-A12B-30	LGN1-A22B-30
GAS	LGN1-A11C-30	LGN1-A21C-30	LGN1-A12C-30	LGN1-A22C-30
NIT	LGN1-A11D-30	LGN1-A21D-30	LGN1-A12D-30	LGN1-A22D-30
OXY	LGN1-A11E-30	LGN1-A21E-30	LGN1-A12E-30	LGN1-A22E-30
HE	LGN1-A11F-30	LGN1-A21F-30	LGN1-A12F-30	LGN1-A22F-30
CO2	LGN1-A11G-30	LGN1-A21G-30	LGN1-A12G-30	LGN1-A22G-30
CO	LGN1-A11H-30	LGN1-A21H-30	LGN1-A12H-30	LGN1-A22H-30
HYD	LGN1-A11I-30	LGN1-A21I-30	LGN1-A12I-30	LGN1-A22I-30
PRO	LGN1-A11J-30	LGN1-A21J-30	LGN1-A12J-30	LGN1-A22J-30
ACET	LGN1-A11K-30	LGN1-A21K-30	LGN1-A12K-30	LGN1-A22K-30
CH4	LGN1-A11L-30	LGN1-A21L-30	LGN1-A12L-30	LGN1-A22L-30
SG	LGN1-A11M-30	LGN1-A21M-30	LGN1-A12M-30	LGN1-A22M-30

## Deck Mounted, Straight Pattern Four Gas Needle Valve Assembly

- Solid brass turret with four outlets
- Solid brass straight valve body
- Polished chrome plated finish
- 2-1/2" vandal proof cross handle
- 3/8" - 18 NPT male thread shank assembly



Index Button	Metal Handle		Plastic Handle	
	Straight Nozzle	30° Nozzle	Straight Nozzle	30° Nozzle
AIR	LGN1-A11A-40	LGN1-A21A-40	LGN1-A12A-40	LGN1-A22A-40
VAC	LGN1-A11B-40	LGN1-A21B-40	LGN1-A12B-40	LGN1-A22B-40
GAS	LGN1-A11C-40	LGN1-A21C-40	LGN1-A12C-40	LGN1-A22C-40
NIT	LGN1-A11D-40	LGN1-A21D-40	LGN1-A12D-40	LGN1-A22D-40
OXY	LGN1-A11E-40	LGN1-A21E-40	LGN1-A12E-40	LGN1-A22E-40
HE	LGN1-A11F-40	LGN1-A21F-40	LGN1-A12F-40	LGN1-A22F-40
CO2	LGN1-A11G-40	LGN1-A21G-40	LGN1-A12G-40	LGN1-A22G-40
CO	LGN1-A11H-40	LGN1-A21H-40	LGN1-A12H-40	LGN1-A22H-40
HYD	LGN1-A11I-40	LGN1-A21I-40	LGN1-A12I-40	LGN1-A22I-40
PRO	LGN1-A11J-40	LGN1-A21J-40	LGN1-A12J-40	LGN1-A22J-40
ACET	LGN1-A11K-40	LGN1-A21K-40	LGN1-A12K-40	LGN1-A22K-40
CH4	LGN1-A11L-40	LGN1-A21L-40	LGN1-A12L-40	LGN1-A22L-40
SG	LGN1-A11M-40	LGN1-A21M-40	LGN1-A12M-40	<b>LGN1-A22M-40</b>

## Wall Mounted, Straight Pattern Single Gas Needle Valve Assembly Less Shank

- Wall flange
- Solid brass straight valve body
- Polished chrome plated finish
- 2-1/2" vandal proof cross handle
- 3/8" - 18 NPT female thread inlet



Index Button	Metal Handle		Plastic Handle	
	Straight Nozzle	30° Nozzle	Straight Nozzle	30° Nozzle
AIR	LGN1-A11A-50	LGN1-A21A-50	LGN1-A12A-50	LGN1-A22A-50
VAC	LGN1-A11B-50	LGN1-A21B-50	LGN1-A12B-50	LGN1-A22B-50
GAS	LGN1-A11C-50	LGN1-A21C-50	LGN1-A12C-50	LGN1-A22C-50
NIT	LGN1-A11D-50	LGN1-A21D-50	LGN1-A12D-50	LGN1-A22D-50
OXY	LGN1-A11E-50	LGN1-A21E-50	LGN1-A12E-50	LGN1-A22E-50
HE	LGN1-A11F-50	LGN1-A21F-50	LGN1-A12F-50	LGN1-A22F-50
CO2	LGN1-A11G-50	LGN1-A21G-50	LGN1-A12G-50	LGN1-A22G-50
CO	<b>LGN1-A11H-50</b>	LGN1-A21H-50	LGN1-A12H-50	LGN1-A22H-50
HYD	LGN1-A11I-50	LGN1-A21I-50	LGN1-A12I-50	LGN1-A22I-50
PRO	LGN1-A11J-50	LGN1-A21J-50	LGN1-A12J-50	LGN1-A22J-50
ACET	LGN1-A11K-50	LGN1-A21K-50	LGN1-A12K-50	LGN1-A22K-50
CH4	LGN1-A11L-50	LGN1-A21L-50	LGN1-A12L-50	LGN1-A22L-50
SG	LGN1-A11M-50	LGN1-A21M-50	LGN1-A12M-50	LGN1-A22M-50

## Wall Mounted, Straight Pattern Single Gas Needle Valve Assembly With Shank

- Wall flange
- Solid brass straight valve body
- Polished chrome plated finish
- 2-1/2" vandal proof cross handle
- 3/8" - 18 NPT male thread shank assembly



Index Button	Metal Handle		Plastic Handle	
	Straight Nozzle	30° Nozzle	Straight Nozzle	30° Nozzle
AIR	LGN1-A11A-55	LGN1-A21A-55	LGN1-A12A-55	LGN1-A22A-55
VAC	LGN1-A11B-55	LGN1-A21B-55	LGN1-A12B-55	LGN1-A22B-55
GAS	LGN1-A11C-55	LGN1-A21C-55	LGN1-A12C-55	LGN1-A22C-55
NIT	LGN1-A11D-55	LGN1-A21D-55	LGN1-A12D-55	LGN1-A22D-55
OXY	LGN1-A11E-55	LGN1-A21E-55	LGN1-A12E-55	LGN1-A22E-55
HE	LGN1-A11F-55	LGN1-A21F-55	<b>LGN1-A12F-55</b>	LGN1-A22F-55
CO2	LGN1-A11G-55	LGN1-A21G-55	LGN1-A12G-55	LGN1-A22G-55
CO	LGN1-A11H-55	LGN1-A21H-55	LGN1-A12H-55	LGN1-A22H-55
HYD	LGN1-A11I-55	LGN1-A21I-55	LGN1-A12I-55	LGN1-A22I-55
PRO	LGN1-A11J-55	LGN1-A21J-55	LGN1-A12J-55	LGN1-A22J-55
ACET	LGN1-A11K-55	LGN1-A21K-55	LGN1-A12K-55	LGN1-A22K-55
CH4	LGN1-A11L-55	LGN1-A21L-55	LGN1-A12L-55	LGN1-A22L-55
SG	LGN1-A11M-55	LGN1-A21M-55	LGN1-A12M-55	LGN1-A22M-55



## Wall Mounted, “Y” Pattern Dual 90° Gas Needle Valve Assembly Less Shank

- “Y” pattern wall flange with two valves at 90°
- Solid brass straight valve body
- Polished chrome plated finish
- 2-1/2” vandal proof cross handle
- 3/8” - 18 NPT female thread inlet



Index Button	Metal Handle		Plastic Handle	
	Straight Nozzle	30° Nozzle	Straight Nozzle	30° Nozzle
AIR	LGN1-A11A-60	LGN1-A21A-60	LGN1-A12A-60	LGN1-A22A-60
VAC	LGN1-A11B-60	LGN1-A21B-60	LGN1-A12B-60	LGN1-A22B-60
GAS	LGN1-A11C-60	LGN1-A21C-60	LGN1-A12C-60	LGN1-A22C-60
NIT	LGN1-A11D-60	<b>LGN1-A21D-60</b>	LGN1-A12D-60	LGN1-A22D-60
OXY	LGN1-A11E-60	LGN1-A21E-60	LGN1-A12E-60	LGN1-A22E-60
HE	LGN1-A11F-60	LGN1-A21F-60	LGN1-A12F-60	LGN1-A22F-60
CO2	LGN1-A11G-60	LGN1-A21G-60	LGN1-A12G-60	LGN1-A22G-60
CO	LGN1-A11H-60	LGN1-A21H-60	LGN1-A12H-60	LGN1-A22H-60
HYD	LGN1-A11I-60	LGN1-A21I-60	LGN1-A12I-60	LGN1-A22I-60
PRO	LGN1-A11J-60	LGN1-A21J-60	LGN1-A12J-60	LGN1-A22J-60
ACET	LGN1-A11K-60	LGN1-A21K-60	LGN1-A12K-60	LGN1-A22K-60
CH4	LGN1-A11L-60	LGN1-A21L-60	LGN1-A12L-60	LGN1-A22L-60
SG	LGN1-A11M-60	LGN1-A21M-60	LGN1-A12M-60	LGN1-A22M-60

## Wall Mounted, “Y” Pattern Dual 90° Gas Needle Valve Assembly With Shank

- “Y” pattern wall flange with two valves at 90°
- Solid brass straight valve body
- Polished chrome plated finish
- 2-1/2” vandal proof cross handle
- 3/8” - 18 NPT male thread shank assembly



Index Button	Metal Handle		Plastic Handle	
	Straight Nozzle	30° Nozzle	Straight Nozzle	30° Nozzle
AIR	LGN1-A11A-65	LGN1-A21A-65	LGN1-A12A-65	LGN1-A22A-65
VAC	LGN1-A11B-65	LGN1-A21B-65	LGN1-A12B-65	LGN1-A22B-65
GAS	LGN1-A11C-65	LGN1-A21C-65	LGN1-A12C-65	LGN1-A22C-65
NIT	LGN1-A11D-65	LGN1-A21D-65	LGN1-A12D-65	LGN1-A22D-65
OXY	LGN1-A11E-65	LGN1-A21E-65	LGN1-A12E-65	LGN1-A22E-65
HE	LGN1-A11F-65	LGN1-A21F-65	LGN1-A12F-65	LGN1-A22F-65
CO2	LGN1-A11G-65	LGN1-A21G-65	LGN1-A12G-65	LGN1-A22G-65
CO	LGN1-A11H-65	LGN1-A21H-65	LGN1-A12H-65	LGN1-A22H-65
HYD	LGN1-A11I-65	LGN1-A21I-65	LGN1-A12I-65	LGN1-A22I-65
PRO	LGN1-A11J-65	LGN1-A21J-65	LGN1-A12J-65	LGN1-A22J-65
ACET	<b>LGN1-A11K-65</b>	LGN1-A21K-65	LGN1-A12K-65	LGN1-A22K-65
CH4	LGN1-A11L-65	LGN1-A21L-65	LGN1-A12L-65	LGN1-A22L-65
SG	LGN1-A11M-65	LGN1-A21M-65	LGN1-A12M-65	LGN1-A22M-65

## Angle Pattern Gas Needle Valve

- Solid brass angle valve body
- Polished chrome plated finish
- 2-1/2" vandal proof cross handle
- 3/8" - 18 NPT female thread inlet



Index Button	Metal Handle		Plastic Handle	
	Straight Nozzle	30° Nozzle	Straight Nozzle	30° Nozzle
AIR	LGN3-A11A	LGN3-A21A	LGN3-A12A	LGN3-A22A
VAC	LGN3-A11B	LGN3-A21B	LGN3-A12B	LGN3-A22B
GAS	LGN3-A11C	LGN3-A21C	LGN3-A12C	LGN3-A22C
NIT	LGN3-A11D	LGN3-A21D	LGN3-A12D	LGN3-A22D
OXY	LGN3-A11E	LGN3-A21E	LGN3-A12E	LGN3-A22E
HE	LGN3-A11F	LGN3-A21F	LGN3-A12F	LGN3-A22F
CO2	LGN3-A11G	LGN3-A21G	LGN3-A12G	LGN3-A22G
CO	LGN3-A11H	LGN3-A21H	LGN3-A12H	LGN3-A22H
HYD	LGN3-A11I	LGN3-A21I	LGN3-A12I	LGN3-A22I
PRO	LGN3-A11J	LGN3-A21J	LGN3-A12J	LGN3-A22J
ACET	LGN3-A11K	LGN3-A21K	LGN3-A12K	LGN3-A22K
CH4	LGN3-A11L	<b>LGN3-A21L</b>	LGN3-A12L	LGN3-A22L
SG	LGN3-A11M	LGN3-A21M	LGN3-A12M	LGN3-A22M

## Overhead Mounted, Angle Pattern Single Gas Needle Valve Assembly

- Solid brass turret with one outlet
- Solid brass angle valve body
- Polished chrome plated finish
- 2-1/2" vandal proof cross handle
- 3/8" - 18 NPT male thread shank assembly



Index Button	Metal Handle		Plastic Handle	
	Straight Nozzle	30° Nozzle	Straight Nozzle	30° Nozzle
AIR	LGN3-A11A-10	LGN3-A21A-10	LGN3-A12A-10	LGN3-A22A-10
VAC	LGN3-A11B-10	LGN3-A21B-10	LGN3-A12B-10	LGN3-A22B-10
GAS	LGN3-A11C-10	LGN3-A21C-10	LGN3-A12C-10	LGN3-A22C-10
NIT	LGN3-A11D-10	LGN3-A21D-10	LGN3-A12D-10	LGN3-A22D-10
OXY	LGN3-A11E-10	LGN3-A21E-10	LGN3-A12E-10	<b>LGN3-A22E-10</b>
HE	LGN3-A11F-10	LGN3-A21F-10	LGN3-A12F-10	LGN3-A22F-10
CO2	LGN3-A11G-10	LGN3-A21G-10	LGN3-A12G-10	LGN3-A22G-10
CO	LGN3-A11H-10	LGN3-A21H-10	LGN3-A12H-10	LGN3-A22H-10
HYD	LGN3-A11I-10	LGN3-A21I-10	LGN3-A12I-10	LGN3-A22I-10
PRO	LGN3-A11J-10	LGN3-A21J-10	LGN3-A12J-10	LGN3-A22J-10
ACET	LGN3-A11K-10	LGN3-A21K-10	LGN3-A12K-10	LGN3-A22K-10
CH4	LGN3-A11L-10	LGN3-A21L-10	LGN3-A12L-10	LGN3-A22L-10
SG	LGN3-A11M-10	LGN3-A21M-10	LGN3-A12M-10	LGN3-A22M-10

## Overhead Mounted, Angle Pattern Dual 90° Gas Needle Valve Assembly

- Solid brass turret with two 90° outlets
- Solid brass angle valve body
- Polished chrome plated finish
- 2-1/2" vandal proof cross handle
- 3/8" - 18 NPT male thread shank assembly



Index Button	Metal Handle		Plastic Handle	
	Straight Nozzle	30° Nozzle	Straight Nozzle	30° Nozzle
AIR	LGN3-A11A-20	LGN3-A21A-20	LGN3-A12A-20	LGN3-A22A-20
VAC	LGN3-A11B-20	LGN3-A21B-20	LGN3-A12B-20	LGN3-A22B-20
GAS	LGN3-A11C-20	LGN3-A21C-20	LGN3-A12C-20	LGN3-A22C-20
NIT	LGN3-A11D-20	LGN3-A21D-20	LGN3-A12D-20	LGN3-A22D-20
OXY	LGN3-A11E-20	LGN3-A21E-20	LGN3-A12E-20	LGN3-A22E-20
HE	<b>LGN3-A11F-20</b>	LGN3-A21F-20	LGN3-A12F-20	LGN3-A22F-20
CO2	LGN3-A11G-20	LGN3-A21G-20	LGN3-A12G-20	LGN3-A22G-20
CO	LGN3-A11H-20	LGN3-A21H-20	LGN3-A12H-20	LGN3-A22H-20
HYD	LGN3-A11I-20	LGN3-A21I-20	LGN3-A12I-20	LGN3-A22I-20
PRO	LGN3-A11J-20	LGN3-A21J-20	LGN3-A12J-20	LGN3-A22J-20
ACET	LGN3-A11K-20	LGN3-A21K-20	LGN3-A12K-20	LGN3-A22K-20
CH4	LGN3-A11L-20	LGN3-A21L-20	LGN3-A12L-20	LGN3-A22L-20
SG	LGN3-A11M-20	LGN3-A21M-20	LGN3-A12M-20	LGN3-A22M-20

## Overhead Mounted, Angle Pattern Dual 180° Gas Needle Valve Assembly

- Solid brass turret with two 180° outlets
- Solid brass angle valve body
- Polished chrome plated finish
- 2-1/2" vandal proof cross handle
- 3/8" - 18 NPT male thread shank assembly

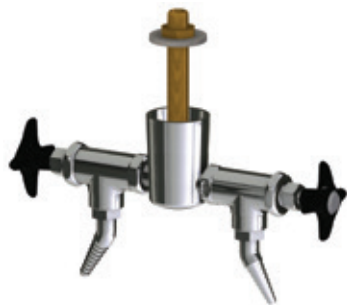

Index Button	Metal Handle		Plastic Handle	
	Straight Nozzle	30° Nozzle	Straight Nozzle	30° Nozzle
AIR	LGN3-A11A-25	LGN3-A21A-25	LGN3-A12A-25	LGN3-A22A-25
VAC	LGN3-A11B-25	LGN3-A21B-25	LGN3-A12B-25	LGN3-A22B-25
GAS	LGN3-A11C-25	LGN3-A21C-25	LGN3-A12C-25	LGN3-A22C-25
NIT	LGN3-A11D-25	LGN3-A21D-25	LGN3-A12D-25	LGN3-A22D-25
OXY	LGN3-A11E-25	LGN3-A21E-25	LGN3-A12E-25	LGN3-A22E-25
HE	LGN3-A11F-25	LGN3-A21F-25	LGN3-A12F-25	LGN3-A22F-25
CO2	LGN3-A11G-25	LGN3-A21G-25	LGN3-A12G-25	LGN3-A22G-25
CO	LGN3-A11H-25	LGN3-A21H-25	LGN3-A12H-25	<b>LGN3-A22H-25</b>
HYD	LGN3-A11I-25	LGN3-A21I-25	LGN3-A12I-25	LGN3-A22I-25
PRO	LGN3-A11J-25	LGN3-A21J-25	LGN3-A12J-25	LGN3-A22J-25
ACET	LGN3-A11K-25	LGN3-A21K-25	LGN3-A12K-25	LGN3-A22K-25
CH4	LGN3-A11L-25	LGN3-A21L-25	LGN3-A12L-25	LGN3-A22L-25
SG	LGN3-A11M-25	LGN3-A21M-25	LGN3-A12M-25	LGN3-A22M-25

## Overhead Mounted, Angle Pattern Three Gas Needle Valve Assembly

- Solid brass turret with three outlets
- Solid brass angle valve body
- Polished chrome plated finish
- 2-1/2" vandal proof cross handle
- 3/8" - 18 NPT male thread shank assembly

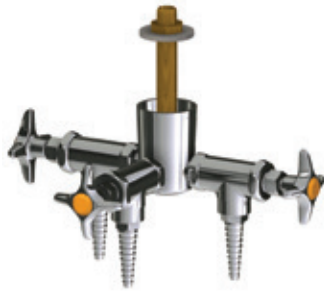

Index Button	Metal Handle		Plastic Handle	
	Straight Nozzle	30° Nozzle	Straight Nozzle	30° Nozzle
AIR	<b>LGN3-A11A-30</b>	LGN3-A21A-30	LGN3-A12A-30	LGN3-A22A-30
VAC	LGN3-A11B-30	LGN3-A21B-30	LGN3-A12B-30	LGN3-A22B-30
GAS	LGN3-A11C-30	LGN3-A21C-30	LGN3-A12C-30	LGN3-A22C-30
NIT	LGN3-A11D-30	LGN3-A21D-30	LGN3-A12D-30	LGN3-A22D-30
OXY	LGN3-A11E-30	LGN3-A21E-30	LGN3-A12E-30	LGN3-A22E-30
HE	LGN3-A11F-30	LGN3-A21F-30	LGN3-A12F-30	LGN3-A22F-30
CO2	LGN3-A11G-30	LGN3-A21G-30	LGN3-A12G-30	LGN3-A22G-30
CO	LGN3-A11H-30	LGN3-A21H-30	LGN3-A12H-30	LGN3-A22H-30
HYD	LGN3-A11I-30	LGN3-A21I-30	LGN3-A12I-30	LGN3-A22I-30
PRO	LGN3-A11J-30	LGN3-A21J-30	LGN3-A12J-30	LGN3-A22J-30
ACET	LGN3-A11K-30	LGN3-A21K-30	LGN3-A12K-30	LGN3-A22K-30
CH4	LGN3-A11L-30	LGN3-A21L-30	LGN3-A12L-30	LGN3-A22L-30
SG	LGN3-A11M-30	LGN3-A21M-30	LGN3-A12M-30	LGN3-A22M-30

## Overhead Mounted, Angle Pattern Four Gas Needle Valve Assembly

- Solid brass turret with four outlets
- Solid brass angle valve body
- Polished chrome plated finish
- 2-1/2" vandal proof cross handle
- 3/8" - 18 NPT male thread shank assembly

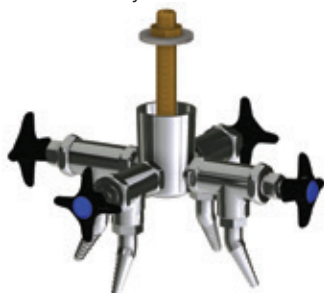

Index Button	Metal Handle		Plastic Handle	
	Straight Nozzle	30° Nozzle	Straight Nozzle	30° Nozzle
AIR	LGN3-A11A-40	LGN3-A21A-40	LGN3-A12A-40	LGN3-A22A-40
VAC	LGN3-A11B-40	LGN3-A21B-40	LGN3-A12B-40	LGN3-A22B-40
GAS	LGN3-A11C-40	LGN3-A21C-40	LGN3-A12C-40	<b>LGN3-A22C-40</b>
NIT	LGN3-A11D-40	LGN3-A21D-40	LGN3-A12D-40	LGN3-A22D-40
OXY	LGN3-A11E-40	LGN3-A21E-40	LGN3-A12E-40	LGN3-A22E-40
HE	LGN3-A11F-40	LGN3-A21F-40	LGN3-A12F-40	LGN3-A22F-40
CO2	LGN3-A11G-40	LGN3-A21G-40	LGN3-A12G-40	LGN3-A22G-40
CO	LGN3-A11H-40	LGN3-A21H-40	LGN3-A12H-40	LGN3-A22H-40
HYD	LGN3-A11I-40	LGN3-A21I-40	LGN3-A12I-40	LGN3-A22I-40
PRO	LGN3-A11J-40	LGN3-A21J-40	LGN3-A12J-40	LGN3-A22J-40
ACET	LGN3-A11K-40	LGN3-A21K-40	LGN3-A12K-40	LGN3-A22K-40
CH4	LGN3-A11L-40	LGN3-A21L-40	LGN3-A12L-40	LGN3-A22L-40
SG	LGN3-A11M-40	LGN3-A21M-40	LGN3-A12M-40	LGN3-A22M-40

## Wall Mounted, Angle Pattern Single Gas Needle Valve Assembly Less Shank

- Wall flange
- Solid brass angle valve body
- Polished chrome plated finish
- 2-1/2" vandal proof cross handle
- 3/8" - 18 NPT female thread inlet



Index Button	Metal Handle		Plastic Handle	
	Straight Nozzle	30° Nozzle	Straight Nozzle	30° Nozzle
AIR	<b>LGN3-A11A-50</b>	LGN3-A21A-50	LGN3-A12A-50	LGN3-A22A-50
VAC	LGN3-A11B-50	LGN3-A21B-50	LGN3-A12B-50	LGN3-A22B-50
GAS	LGN3-A11C-50	LGN3-A21C-50	LGN3-A12C-50	LGN3-A22C-50
NIT	LGN3-A11D-50	LGN3-A21D-50	LGN3-A12D-50	LGN3-A22D-50
OXY	LGN3-A11E-50	LGN3-A21E-50	LGN3-A12E-50	LGN3-A22E-50
HE	LGN3-A11F-50	LGN3-A21F-50	LGN3-A12F-50	LGN3-A22F-50
CO2	LGN3-A11G-50	LGN3-A21G-50	LGN3-A12G-50	LGN3-A22G-50
CO	LGN3-A11H-50	LGN3-A21H-50	LGN3-A12H-50	LGN3-A22H-50
HYD	LGN3-A11I-50	LGN3-A21I-50	LGN3-A12I-50	LGN3-A22I-50
PRO	LGN3-A11J-50	LGN3-A21J-50	LGN3-A12J-50	LGN3-A22J-50
ACET	LGN3-A11K-50	LGN3-A21K-50	LGN3-A12K-50	LGN3-A22K-50
CH4	LGN3-A11L-50	LGN3-A21L-50	LGN3-A12L-50	LGN3-A22L-50
SG	LGN3-A11M-50	LGN3-A21M-50	LGN3-A12M-50	LGN3-A22M-50

## Wall Mounted, Angle Pattern Single Gas Needle Valve Assembly With Shank

- Wall flange
- Solid brass angle valve body
- Polished chrome plated finish
- 2-1/2" vandal proof cross handle
- 3/8" - 18 NPT male thread shank assembly



Index Button	Metal Handle		Plastic Handle	
	Straight Nozzle	30° Nozzle	Straight Nozzle	30° Nozzle
AIR	LGN3-A11A-55	LGN3-A21A-55	LGN3-A12A-55	LGN3-A22A-55
VAC	LGN3-A11B-55	LGN3-A21B-55	LGN3-A12B-55	LGN3-A22B-55
GAS	LGN3-A11C-55	LGN3-A21C-55	LGN3-A12C-55	LGN3-A22C-55
NIT	LGN3-A11D-55	LGN3-A21D-55	LGN3-A12D-55	LGN3-A22D-55
OXY	LGN3-A11E-55	LGN3-A21E-55	LGN3-A12E-55	LGN3-A22E-55
HE	LGN3-A11F-55	LGN3-A21F-55	LGN3-A12F-55	LGN3-A22F-55
CO2	LGN3-A11G-55	LGN3-A21G-55	LGN3-A12G-55	LGN3-A22G-55
CO	LGN3-A11H-55	LGN3-A21H-55	LGN3-A12H-55	LGN3-A22H-55
HYD	LGN3-A11I-55	LGN3-A21I-55	LGN3-A12I-55	LGN3-A22I-55
PRO	LGN3-A11J-55	LGN3-A21J-55	LGN3-A12J-55	LGN3-A22J-55
ACET	LGN3-A11K-55	LGN3-A21K-55	LGN3-A12K-55	LGN3-A22K-55
CH4	LGN3-A11L-55	LGN3-A21L-55	LGN3-A12L-55	LGN3-A22L-55
SG	LGN3-A11M-55	LGN3-A21M-55	<b>LGN3-A12M-55</b>	LGN3-A22M-55

## Wall Mounted, “Y” Pattern Dual 90° Gas Needle Valve Assembly Less Shank

- “Y” pattern wall flange with two valves at 90°
- Solid brass angle valve body
- Polished chrome plated finish
- 2-1/2” vandal proof cross handle
- 3/8” - 18 NPT female thread inlet



Index Button	Metal Handle		Plastic Handle	
	Straight Nozzle	30° Nozzle	Straight Nozzle	30° Nozzle
AIR	LGN3-A11A-60	LGN3-A21A-60	LGN3-A12A-60	LGN3-A22A-60
VAC	LGN3-A11B-60	<b>LGN3-A21B-60</b>	LGN3-A12B-60	LGN3-A22B-60
GAS	LGN3-A11C-60	LGN3-A21C-60	LGN3-A12C-60	LGN3-A22C-60
NIT	LGN3-A11D-60	LGN3-A21D-60	LGN3-A12D-60	LGN3-A22D-60
OXY	LGN3-A11E-60	LGN3-A21E-60	LGN3-A12E-60	LGN3-A22E-60
HE	LGN3-A11F-60	LGN3-A21F-60	LGN3-A12F-60	LGN3-A22F-60
CO2	LGN3-A11G-60	LGN3-A21G-60	LGN3-A12G-60	LGN3-A22G-60
CO	LGN3-A11H-60	LGN3-A21H-60	LGN3-A12H-60	LGN3-A22H-60
HYD	LGN3-A11I-60	LGN3-A21I-60	LGN3-A12I-60	LGN3-A22I-60
PRO	LGN3-A11J-60	LGN3-A21J-60	LGN3-A12J-60	LGN3-A22J-60
ACET	LGN3-A11K-60	LGN3-A21K-60	LGN3-A12K-60	LGN3-A22K-60
CH4	LGN3-A11L-60	LGN3-A21L-60	LGN3-A12L-60	LGN3-A22L-60
SG	LGN3-A11M-60	LGN3-A21M-60	LGN3-A12M-60	LGN3-A22M-60

## Wall Mounted, “Y” Pattern Dual 90° Gas Needle Valve Assembly With Shank

- “Y” pattern wall flange with two valves at 90°
- Solid brass angle valve body
- Polished chrome plated finish
- 2-1/2” vandal proof cross handle
- 3/8” - 18 NPT male thread shank assembly



Index Button	Metal Handle		Plastic Handle	
	Straight Nozzle	30° Nozzle	Straight Nozzle	30° Nozzle
AIR	LGN3-A11A-65	LGN3-A21A-65	LGN3-A12A-65	LGN3-A22A-65
VAC	LGN3-A11B-65	LGN3-A21B-65	LGN3-A12B-65	LGN3-A22B-65
GAS	LGN3-A11C-65	LGN3-A21C-65	LGN3-A12C-65	<b>LGN3-A22C-65</b>
NIT	LGN3-A11D-65	LGN3-A21D-65	LGN3-A12D-65	LGN3-A22D-65
OXY	LGN3-A11E-65	LGN3-A21E-65	LGN3-A12E-65	LGN3-A22E-65
HE	LGN3-A11F-65	LGN3-A21F-65	LGN3-A12F-65	LGN3-A22F-65
CO2	LGN3-A11G-65	LGN3-A21G-65	LGN3-A12G-65	LGN3-A22G-65
CO	LGN3-A11H-65	LGN3-A21H-65	LGN3-A12H-65	LGN3-A22H-65
HYD	LGN3-A11I-65	LGN3-A21I-65	LGN3-A12I-65	LGN3-A22I-65
PRO	LGN3-A11J-65	LGN3-A21J-65	LGN3-A12J-65	LGN3-A22J-65
ACET	LGN3-A11K-65	LGN3-A21K-65	LGN3-A12K-65	LGN3-A22K-65
CH4	LGN3-A11L-65	LGN3-A21L-65	LGN3-A12L-65	LGN3-A22L-65
SG	LGN3-A11M-65	LGN3-A21M-65	LGN3-A12M-65	LGN3-A22M-65



## How to build and order a Chicago Faucets laboratory fine control gas needle valve fitting.

Chicago Faucets makes it easy for you to build fine control gas needle valve fittings that meet your exact requirements. You can reference the charts on the following pages, or you can build your own valve by choosing the components below to configure your model number.

**LGF** A - B C D E - F  
 (Lab Gas Fine Control)

### Valve Base

A



Straight Valve



Angle Valve

### Cartridge

B



Compression

### Outlet

C

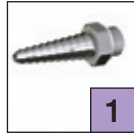

Straight Nozzle



30° Nozzle

### EXAMPLE



#### LGF1-A21A-25

Straight valves with 30° outlets, metal lever handles with AIR index buttons, and single hole turret.

### Handle

D



Metal

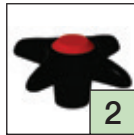

Plastic

### Button

E

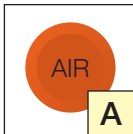

Air

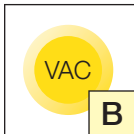

Vacuum

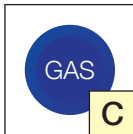

Gas

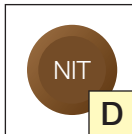

Nitrogen

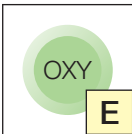

Oxygen

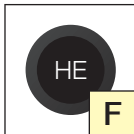

Helium

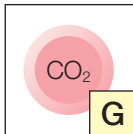

Carbon Dioxide

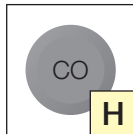

Carbon Monoxide

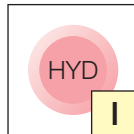

Hydrogen

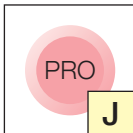

Propane

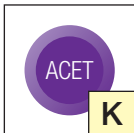

Acetylene

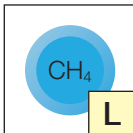

Methane

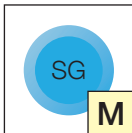

Specialty Gas

### Turret

F



Single



Dual 90°



Dual 180°



Three Hole



Four Hole



Single Wall Flange



Single Wall Flange with Shank



Dual Wall Flange

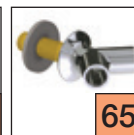

Dual Wall Flange with Shank



## Straight Pattern Gas Fine Control Needle Valve

- Solid brass straight valve body
- Polished chrome plated finish
- 2-1/2" vandal proof cross handle
- 3/8" - 18 NPT male thread inlet



Index Button	Metal Handle		Plastic Handle	
	Straight Nozzle	30° Nozzle	Straight Nozzle	30° Nozzle
AIR	<b>LGF1-A11A</b>	LGF1-A21A	LGF1-A12A	LGF1-A22A
VAC	LGF1-A11B	LGF1-A21B	LGF1-A12B	LGF1-A22B
GAS	LGF1-A11C	LGF1-A21C	LGF1-A12C	LGF1-A22C
NIT	LGF1-A11D	LGF1-A21D	LGF1-A12D	LGF1-A22D
OXY	LGF1-A11E	LGF1-A21E	LGF1-A12E	LGF1-A22E
HE	LGF1-A11F	LGF1-A21F	LGF1-A12F	LGF1-A22F
CO2	LGF1-A11G	LGF1-A21G	LGF1-A12G	LGF1-A22G
CO	LGF1-A11H	LGF1-A21H	LGF1-A12H	LGF1-A22H
HYD	LGF1-A11I	LGF1-A21I	LGF1-A12I	LGF1-A22I
PRO	LGF1-A11J	LGF1-A21J	LGF1-A12J	LGF1-A22J
ACET	LGF1-A11K	LGF1-A21K	LGF1-A12K	LGF1-A22K
CH4	LGF1-A11L	LGF1-A21L	LGF1-A12L	LGF1-A22L
SG	LGF1-A11M	LGF1-A21M	LGF1-A12M	LGF1-A22M

## Deck Mounted, Straight Pattern Single Gas Fine Control Needle Valve Assembly

- Solid brass turret with one outlet
- Solid brass straight valve body
- Polished chrome plated finish
- 2-1/2" vandal proof cross handle
- 3/8" - 18 NPT male thread shank assembly



Index Button	Metal Handle		Plastic Handle	
	Straight Nozzle	30° Nozzle	Straight Nozzle	30° Nozzle
AIR	LGF1-A11A-10	LGF1-A21A-10	LGF1-A12A-10	LGF1-A22A-10
VAC	LGF1-A11B-10	LGF1-A21B-10	LGF1-A12B-10	LGF1-A22B-10
GAS	LGF1-A11C-10	LGF1-A21C-10	LGF1-A12C-10	<b>LGF1-A22C-10</b>
NIT	LGF1-A11D-10	LGF1-A21D-10	LGF1-A12D-10	LGF1-A22D-10
OXY	LGF1-A11E-10	LGF1-A21E-10	LGF1-A12E-10	LGF1-A22E-10
HE	LGF1-A11F-10	LGF1-A21F-10	LGF1-A12F-10	LGF1-A22F-10
CO2	LGF1-A11G-10	LGF1-A21G-10	LGF1-A12G-10	LGF1-A22G-10
CO	LGF1-A11H-10	LGF1-A21H-10	LGF1-A12H-10	LGF1-A22H-10
HYD	LGF1-A11I-10	LGF1-A21I-10	LGF1-A12I-10	LGF1-A22I-10
PRO	LGF1-A11J-10	LGF1-A21J-10	LGF1-A12J-10	LGF1-A22J-10
ACET	LGF1-A11K-10	LGF1-A21K-10	LGF1-A12K-10	LGF1-A22K-10
CH4	LGF1-A11L-10	LGF1-A21L-10	LGF1-A12L-10	LGF1-A22L-10
SG	LGF1-A11M-10	LGF1-A21M-10	LGF1-A12M-10	LGF1-A22M-10

## Deck Mounted, Straight Pattern Dual 90° Gas Fine Control Needle Valve Assembly

- Solid brass turret with two 90° outlets
- Solid brass straight valve body
- Polished chrome plated finish
- 2-1/2" vandal proof cross handle
- 3/8" - 18 NPT male thread shank assembly



Index Button	Metal Handle		Plastic Handle	
	Straight Nozzle	30° Nozzle	Straight Nozzle	30° Nozzle
AIR	LGF1-A11A-20	LGF1-A21A-20	LGF1-A12A-20	LGF1-A22A-20
VAC	LGF1-A11B-20	LGF1-A21B-20	LGF1-A12B-20	LGF1-A22B-20
GAS	LGF1-A11C-20	<b>LGF1-A21C-20</b>	LGF1-A12C-20	LGF1-A22C-20
NIT	LGF1-A11D-20	LGF1-A21D-20	LGF1-A12D-20	LGF1-A22D-20
OXY	LGF1-A11E-20	LGF1-A21E-20	LGF1-A12E-20	LGF1-A22E-20
HE	LGF1-A11F-20	LGF1-A21F-20	LGF1-A12F-20	LGF1-A22F-20
CO2	LGF1-A11G-20	LGF1-A21G-20	LGF1-A12G-20	LGF1-A22G-20
CO	LGF1-A11H-20	LGF1-A21H-20	LGF1-A12H-20	LGF1-A22H-20
HYD	LGF1-A11I-20	LGF1-A21I-20	LGF1-A12I-20	LGF1-A22I-20
PRO	LGF1-A11J-20	LGF1-A21J-20	LGF1-A12J-20	LGF1-A22J-20
ACET	LGF1-A11K-20	LGF1-A21K-20	LGF1-A12K-20	LGF1-A22K-20
CH4	LGF1-A11L-20	LGF1-A21L-20	LGF1-A12L-20	LGF1-A22L-20
SG	LGF1-A11M-20	LGF1-A21M-20	LGF1-A12M-20	LGF1-A22M-20

## Deck Mounted, Straight Pattern Dual 180° Gas Fine Control Needle Valve Assembly

- Solid brass turret with two 180° outlets
- Solid brass straight valve body
- Polished chrome plated finish
- 2-1/2" vandal proof cross handle
- 3/8" - 18 NPT male thread shank assembly



Index Button	Metal Handle		Plastic Handle	
	Straight Nozzle	30° Nozzle	Straight Nozzle	30° Nozzle
AIR	LGF1-A11A-25	LGF1-A21A-25	LGF1-A12A-25	LGF1-A22A-25
VAC	LGF1-A11B-25	LGF1-A21B-25	<b>LGF1-A12B-25</b>	LGF1-A22B-25
GAS	LGF1-A11C-25	LGF1-A21C-25	LGF1-A12C-25	LGF1-A22C-25
NIT	LGF1-A11D-25	LGF1-A21D-25	LGF1-A12D-25	LGF1-A22D-25
OXY	LGF1-A11E-25	LGF1-A21E-25	LGF1-A12E-25	LGF1-A22E-25
HE	LGF1-A11F-25	LGF1-A21F-25	LGF1-A12F-25	LGF1-A22F-25
CO2	LGF1-A11G-25	LGF1-A21G-25	LGF1-A12G-25	LGF1-A22G-25
CO	LGF1-A11H-25	LGF1-A21H-25	LGF1-A12H-25	LGF1-A22H-25
HYD	LGF1-A11I-25	LGF1-A21I-25	LGF1-A12I-25	LGF1-A22I-25
PRO	LGF1-A11J-25	LGF1-A21J-25	LGF1-A12J-25	LGF1-A22J-25
ACET	LGF1-A11K-25	LGF1-A21K-25	LGF1-A12K-25	LGF1-A22K-25
CH4	LGF1-A11L-25	LGF1-A21L-25	LGF1-A12L-25	LGF1-A22L-25
SG	LGF1-A11M-25	LGF1-A21M-25	LGF1-A12M-25	LGF1-A22M-25

## Deck Mounted, Straight Pattern Three Gas Fine Control Needle Valve Assembly

- Solid brass turret with three outlets
- Solid brass straight valve body
- Polished chrome plated finish
- 2-1/2" vandal proof cross handle
- 3/8" - 18 NPT male thread shank assembly



Index Button	Metal Handle		Plastic Handle	
	Straight Nozzle	30° Nozzle	Straight Nozzle	30° Nozzle
AIR	<b>LGF1-A11A-30</b>	LGF1-A21A-30	LGF1-A12A-30	LGF1-A22A-30
VAC	LGF1-A11B-30	LGF1-A21B-30	LGF1-A12B-30	LGF1-A22B-30
GAS	LGF1-A11C-30	LGF1-A21C-30	LGF1-A12C-30	LGF1-A22C-30
NIT	LGF1-A11D-30	LGF1-A21D-30	LGF1-A12D-30	LGF1-A22D-30
OXY	LGF1-A11E-30	LGF1-A21E-30	LGF1-A12E-30	LGF1-A22E-30
HE	LGF1-A11F-30	LGF1-A21F-30	LGF1-A12F-30	LGF1-A22F-30
CO2	LGF1-A11G-30	LGF1-A21G-30	LGF1-A12G-30	LGF1-A22G-30
CO	LGF1-A11H-30	LGF1-A21H-30	LGF1-A12H-30	LGF1-A22H-30
HYD	LGF1-A11I-30	LGF1-A21I-30	LGF1-A12I-30	LGF1-A22I-30
PRO	LGF1-A11J-30	LGF1-A21J-30	LGF1-A12J-30	LGF1-A22J-30
ACET	LGF1-A11K-30	LGF1-A21K-30	LGF1-A12K-30	LGF1-A22K-30
CH4	LGF1-A11L-30	LGF1-A21L-30	LGF1-A12L-30	LGF1-A22L-30
SG	LGF1-A11M-30	LGF1-A21M-30	LGF1-A12M-30	LGF1-A22M-30

## Deck Mounted, Straight Pattern Four Gas Fine Control Needle Valve Assembly

- Solid brass turret with four outlets
- Solid brass straight valve body
- Polished chrome plated finish
- 2-1/2" vandal proof cross handle
- 3/8" - 18 NPT male thread shank assembly



Index Button	Metal Handle		Plastic Handle	
	Straight Nozzle	30° Nozzle	Straight Nozzle	30° Nozzle
AIR	LGF1-A11A-40	LGF1-A21A-40	LGF1-A12A-40	LGF1-A22A-40
VAC	LGF1-A11B-40	LGF1-A21B-40	LGF1-A12B-40	LGF1-A22B-40
GAS	LGF1-A11C-40	LGF1-A21C-40	LGF1-A12C-40	LGF1-A22C-40
NIT	LGF1-A11D-40	LGF1-A21D-40	LGF1-A12D-40	LGF1-A22D-40
OXY	LGF1-A11E-40	LGF1-A21E-40	LGF1-A12E-40	LGF1-A22E-40
HE	LGF1-A11F-40	LGF1-A21F-40	LGF1-A12F-40	LGF1-A22F-40
CO2	LGF1-A11G-40	LGF1-A21G-40	LGF1-A12G-40	LGF1-A22G-40
CO	LGF1-A11H-40	LGF1-A21H-40	LGF1-A12H-40	LGF1-A22H-40
HYD	LGF1-A11I-40	LGF1-A21I-40	LGF1-A12I-40	LGF1-A22I-40
PRO	LGF1-A11J-40	LGF1-A21J-40	LGF1-A12J-40	LGF1-A22J-40
ACET	LGF1-A11K-40	LGF1-A21K-40	LGF1-A12K-40	LGF1-A22K-40
CH4	LGF1-A11L-40	LGF1-A21L-40	LGF1-A12L-40	LGF1-A22L-40
SG	LGF1-A11M-40	LGF1-A21M-40	LGF1-A12M-40	<b>LGF1-A22M-40</b>

## Wall Mounted, Straight Pattern Single Gas Fine Control Needle Valve Assembly Less Shank

- Wall flange
- Solid brass wall flange and straight valve body
- Polished chrome plated finish
- 2-1/2" vandal proof cross handle
- 3/8" - 18 NPT female thread inlet



Index Button	Metal Handle		Plastic Handle	
	Straight Nozzle	30° Nozzle	Straight Nozzle	30° Nozzle
AIR	LGF1-A11A-50	LGF1-A21A-50	LGF1-A12A-50	LGF1-A22A-50
VAC	LGF1-A11B-50	LGF1-A21B-50	LGF1-A12B-50	LGF1-A22B-50
GAS	LGF1-A11C-50	LGF1-A21C-50	LGF1-A12C-50	LGF1-A22C-50
NIT	LGF1-A11D-50	LGF1-A21D-50	LGF1-A12D-50	LGF1-A22D-50
OXY	LGF1-A11E-50	LGF1-A21E-50	LGF1-A12E-50	LGF1-A22E-50
HE	LGF1-A11F-50	LGF1-A21F-50	LGF1-A12F-50	LGF1-A22F-50
CO2	LGF1-A11G-50	LGF1-A21G-50	LGF1-A12G-50	LGF1-A22G-50
CO	<b>LGF1-A11H-50</b>	LGF1-A21H-50	LGF1-A12H-50	LGF1-A22H-50
HYD	LGF1-A11I-50	LGF1-A21I-50	LGF1-A12I-50	LGF1-A22I-50
PRO	LGF1-A11J-50	LGF1-A21J-50	LGF1-A12J-50	LGF1-A22J-50
ACET	LGF1-A11K-50	LGF1-A21K-50	LGF1-A12K-50	LGF1-A22K-50
CH4	LGF1-A11L-50	LGF1-A21L-50	LGF1-A12L-50	LGF1-A22L-50
SG	LGF1-A11M-50	LGF1-A21M-50	LGF1-A12M-50	LGF1-A22M-50

## Wall Mounted, Straight Pattern Single Gas Fine Control Needle Valve Assembly With Shank

- Wall flange
- Solid brass wall flange and straight valve body with shank
- Polished chrome plated finish
- 2-1/2" vandal proof cross handle
- 3/8" - 18 NPT male thread shank assembly



Index Button	Metal Handle		Plastic Handle	
	Straight Nozzle	30° Nozzle	Straight Nozzle	30° Nozzle
AIR	LGF1-A11A-55	LGF1-A21A-55	LGF1-A12A-55	LGF1-A22A-55
VAC	LGF1-A11B-55	LGF1-A21B-55	LGF1-A12B-55	LGF1-A22B-55
GAS	LGF1-A11C-55	LGF1-A21C-55	LGF1-A12C-55	LGF1-A22C-55
NIT	LGF1-A11D-55	LGF1-A21D-55	LGF1-A12D-55	LGF1-A22D-55
OXY	LGF1-A11E-55	LGF1-A21E-55	LGF1-A12E-55	LGF1-A22E-55
HE	LGF1-A11F-55	LGF1-A21F-55	<b>LGF1-A12F-55</b>	LGF1-A22F-55
CO2	LGF1-A11G-55	LGF1-A21G-55	LGF1-A12G-55	LGF1-A22G-55
CO	LGF1-A11H-55	LGF1-A21H-55	LGF1-A12H-55	LGF1-A22H-55
HYD	LGF1-A11I-55	LGF1-A21I-55	LGF1-A12I-55	LGF1-A22I-55
PRO	LGF1-A11J-55	LGF1-A21J-55	LGF1-A12J-55	LGF1-A22J-55
ACET	LGF1-A11K-55	LGF1-A21K-55	LGF1-A12K-55	LGF1-A22K-55
CH4	LGF1-A11L-55	LGF1-A21L-55	LGF1-A12L-55	LGF1-A22L-55
SG	LGF1-A11M-55	LGF1-A21M-55	LGF1-A12M-55	LGF1-A22M-55

## Wall Mounted, “Y” Pattern Dual 90° Gas Fine Control Needle Valve Assembly Less Shank

- “Y” pattern wall flange with two valves at 90°
- Polished chrome plated finish
- 2-1/2” vandal proof cross handle
- 3/8” - 18 NPT female thread inlet



Index Button	Metal Handle		Plastic Handle	
	Straight Nozzle	30° Nozzle	Straight Nozzle	30° Nozzle
AIR	LGF1-A11A-60	LGF1-A21A-60	LGF1-A12A-60	LGF1-A22A-60
VAC	LGF1-A11B-60	LGF1-A21B-60	LGF1-A12B-60	LGF1-A22B-60
GAS	LGF1-A11C-60	LGF1-A21C-60	LGF1-A12C-60	LGF1-A22C-60
NIT	LGF1-A11D-60	<b>LGF1-A21D-60</b>	LGF1-A12D-60	LGF1-A22D-60
OXY	LGF1-A11E-60	LGF1-A21E-60	LGF1-A12E-60	LGF1-A22E-60
HE	LGF1-A11F-60	LGF1-A21F-60	LGF1-A12F-60	LGF1-A22F-60
CO2	LGF1-A11G-60	LGF1-A21G-60	LGF1-A12G-60	LGF1-A22G-60
CO	LGF1-A11H-60	LGF1-A21H-60	LGF1-A12H-60	LGF1-A22H-60
HYD	LGF1-A11I-60	LGF1-A21I-60	LGF1-A12I-60	LGF1-A22I-60
PRO	LGF1-A11J-60	LGF1-A21J-60	LGF1-A12J-60	LGF1-A22J-60
ACET	LGF1-A11K-60	LGF1-A21K-60	LGF1-A12K-60	LGF1-A22K-60
CH4	LGF1-A11L-60	LGF1-A21L-60	LGF1-A12L-60	LGF1-A22L-60
SG	LGF1-A11M-60	LGF1-A21M-60	LGF1-A12M-60	LGF1-A22M-60

## Wall Mounted, “Y” Pattern Dual 90° Gas Fine Control Needle Valve Assembly With Shank

- “Y” pattern wall flange with two valves at 90°
- Solid brass straight valve body
- Polished chrome plated finish
- 2-1/2” vandal proof cross handle
- 3/8” - 18 NPT male thread shank assembly



Index Button	Metal Handle		Plastic Handle	
	Straight Nozzle	30° Nozzle	Straight Nozzle	30° Nozzle
AIR	LGF1-A11A-65	LGF1-A21A-65	LGF1-A12A-65	LGF1-A22A-65
VAC	LGF1-A11B-65	LGF1-A21B-65	LGF1-A12B-65	LGF1-A22B-65
GAS	LGF1-A11C-65	LGF1-A21C-65	LGF1-A12C-65	LGF1-A22C-65
NIT	LGF1-A11D-65	LGF1-A21D-65	LGF1-A12D-65	LGF1-A22D-65
OXY	LGF1-A11E-65	LGF1-A21E-65	LGF1-A12E-65	LGF1-A22E-65
HE	LGF1-A11F-65	LGF1-A21F-65	LGF1-A12F-65	LGF1-A22F-65
CO2	LGF1-A11G-65	LGF1-A21G-65	LGF1-A12G-65	LGF1-A22G-65
CO	LGF1-A11H-65	LGF1-A21H-65	LGF1-A12H-65	LGF1-A22H-65
HYD	LGF1-A11I-65	LGF1-A21I-65	LGF1-A12I-65	LGF1-A22I-65
PRO	LGF1-A11J-65	LGF1-A21J-65	LGF1-A12J-65	LGF1-A22J-65
ACET	<b>LGF1-A11K-65</b>	LGF1-A21K-65	LGF1-A12K-65	LGF1-A22K-65
CH4	LGF1-A11L-65	LGF1-A21L-65	LGF1-A12L-65	LGF1-A22L-65
SG	LGF1-A11M-65	LGF1-A21M-65	LGF1-A12M-65	LGF1-A22M-65

## Angle Pattern Gas Fine Control Needle Valve

- Solid brass angle valve body
- Polished chrome plated finish
- 2-1/2" vandal proof cross handle
- 3/8" - 18 NPT female thread inlet



Index Button	Metal Handle		Plastic Handle	
	Straight Nozzle	30° Nozzle	Straight Nozzle	30° Nozzle
AIR	LGF3-A11A	LGF3-A21A	LGF3-A12A	LGF3-A22A
VAC	LGF3-A11B	LGF3-A21B	LGF3-A12B	LGF3-A22B
GAS	LGF3-A11C	LGF3-A21C	LGF3-A12C	LGF3-A22C
NIT	LGF3-A11D	LGF3-A21D	LGF3-A12D	LGF3-A22D
OXY	LGF3-A11E	LGF3-A21E	LGF3-A12E	LGF3-A22E
HE	LGF3-A11F	LGF3-A21F	LGF3-A12F	LGF3-A22F
CO2	LGF3-A11G	LGF3-A21G	LGF3-A12G	LGF3-A22G
CO	LGF3-A11H	LGF3-A21H	LGF3-A12H	LGF3-A22H
HYD	LGF3-A11I	LGF3-A21I	LGF3-A12I	LGF3-A22I
PRO	LGF3-A11J	LGF3-A21J	LGF3-A12J	LGF3-A22J
ACET	LGF3-A11K	LGF3-A21K	LGF3-A12K	LGF3-A22K
CH4	LGF3-A11L	<b>LGF3-A21L</b>	LGF3-A12L	LGF3-A22L
SG	LGF3-A11M	LGF3-A21M	LGF3-A12M	LGF3-A22M

## Overhead Mounted, Angle Pattern Single Gas Fine Control Needle Valve Assembly

- Solid brass turret with one outlet
- Solid brass angle valve body
- Polished chrome plated finish
- 2-1/2" vandal proof cross handle
- 3/8" - 18 NPT male thread shank assembly



Index Button	Metal Handle		Plastic Handle	
	Straight Nozzle	30° Nozzle	Straight Nozzle	30° Nozzle
AIR	LGF3-A11A-10	LGF3-A21A-10	LGF3-A12A-10	LGF3-A22A-10
VAC	LGF3-A11B-10	LGF3-A21B-10	LGF3-A12B-10	LGF3-A22B-10
GAS	LGF3-A11C-10	LGF3-A21C-10	LGF3-A12C-10	LGF3-A22C-10
NIT	LGF3-A11D-10	LGF3-A21D-10	LGF3-A12D-10	LGF3-A22D-10
OXY	LGF3-A11E-10	LGF3-A21E-10	LGF3-A12E-10	<b>LGF3-A22E-10</b>
HE	LGF3-A11F-10	LGF3-A21F-10	LGF3-A12F-10	LGF3-A22F-10
CO2	LGF3-A11G-10	LGF3-A21G-10	LGF3-A12G-10	LGF3-A22G-10
CO	LGF3-A11H-10	LGF3-A21H-10	LGF3-A12H-10	LGF3-A22H-10
HYD	LGF3-A11I-10	LGF3-A21I-10	LGF3-A12I-10	LGF3-A22I-10
PRO	LGF3-A11J-10	LGF3-A21J-10	LGF3-A12J-10	LGF3-A22J-10
ACET	LGF3-A11K-10	LGF3-A21K-10	LGF3-A12K-10	LGF3-A22K-10
CH4	LGF3-A11L-10	LGF3-A21L-10	LGF3-A12L-10	LGF3-A22L-10
SG	LGF3-A11M-10	LGF3-A21M-10	LGF3-A12M-10	LGF3-A22M-10

## Overhead Mounted, Angle Pattern Dual 90° Gas Fine Control Needle Valve Assembly

- Solid brass turret with two 90° outlets
- Solid brass angle valve body
- Polished chrome plated finish
- 2-1/2" vandal proof cross handle
- 3/8" - 18 NPT male thread shank assembly



Index Button	Metal Handle		Plastic Handle	
	Straight Nozzle	30° Nozzle	Straight Nozzle	30° Nozzle
AIR	LGF3-A11A-20	LGF3-A21A-20	LGF3-A12A-20	LGF3-A22A-20
VAC	LGF3-A11B-20	LGF3-A21B-20	LGF3-A12B-20	LGF3-A22B-20
GAS	LGF3-A11C-20	LGF3-A21C-20	LGF3-A12C-20	LGF3-A22C-20
NIT	LGF3-A11D-20	LGF3-A21D-20	LGF3-A12D-20	LGF3-A22D-20
OXY	LGF3-A11E-20	LGF3-A21E-20	LGF3-A12E-20	LGF3-A22E-20
HE	<b>LGF3-A11F-20</b>	LGF3-A21F-20	LGF3-A12F-20	LGF3-A22F-20
CO2	LGF3-A11G-20	LGF3-A21G-20	LGF3-A12G-20	LGF3-A22G-20
CO	LGF3-A11H-20	LGF3-A21H-20	LGF3-A12H-20	LGF3-A22H-20
HYD	LGF3-A11I-20	LGF3-A21I-20	LGF3-A12I-20	LGF3-A22I-20
PRO	LGF3-A11J-20	LGF3-A21J-20	LGF3-A12J-20	LGF3-A22J-20
ACET	LGF3-A11K-20	LGF3-A21K-20	LGF3-A12K-20	LGF3-A22K-20
CH4	LGF3-A11L-20	LGF3-A21L-20	LGF3-A12L-20	LGF3-A22L-20
SG	LGF3-A11M-20	LGF3-A21M-20	LGF3-A12M-20	LGF3-A22M-20

## Overhead Mounted, Angle Pattern Dual 180° Gas Fine Control Needle Valve Assembly

- Solid brass turret with two 180° outlets
- Solid brass angle valve body
- Polished chrome plated finish
- 2-1/2" vandal proof cross handle
- 3/8" - 18 NPT male thread shank assembly

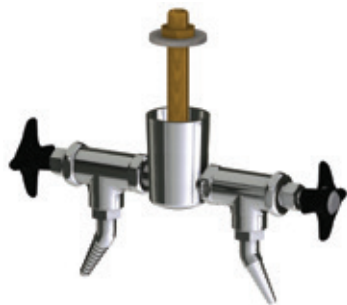

Index Button	Metal Handle		Plastic Handle	
	Straight Nozzle	30° Nozzle	Straight Nozzle	30° Nozzle
AIR	LGF3-A11A-25	LGF3-A21A-25	LGF3-A12A-25	LGF3-A22A-25
VAC	LGF3-A11B-25	LGF3-A21B-25	LGF3-A12B-25	LGF3-A22B-25
GAS	LGF3-A11C-25	LGF3-A21C-25	LGF3-A12C-25	LGF3-A22C-25
NIT	LGF3-A11D-25	LGF3-A21D-25	LGF3-A12D-25	LGF3-A22D-25
OXY	LGF3-A11E-25	LGF3-A21E-25	LGF3-A12E-25	LGF3-A22E-25
HE	LGF3-A11F-25	LGF3-A21F-25	LGF3-A12F-25	LGF3-A22F-25
CO2	LGF3-A11G-25	LGF3-A21G-25	LGF3-A12G-25	LGF3-A22G-25
CO	LGF3-A11H-25	LGF3-A21H-25	LGF3-A12H-25	<b>LGF3-A22H-25</b>
HYD	LGF3-A11I-25	LGF3-A21I-25	LGF3-A12I-25	LGF3-A22I-25
PRO	LGF3-A11J-25	LGF3-A21J-25	LGF3-A12J-25	LGF3-A22J-25
ACET	LGF3-A11K-25	LGF3-A21K-25	LGF3-A12K-25	LGF3-A22K-25
CH4	LGF3-A11L-25	LGF3-A21L-25	LGF3-A12L-25	LGF3-A22L-25
SG	LGF3-A11M-25	LGF3-A21M-25	LGF3-A12M-25	LGF3-A22M-25

## Overhead Mounted, Angle Pattern Three Gas Fine Control Needle Valve Assembly

- Solid brass turret with three outlets
- Solid brass angle valve body
- Polished chrome plated finish
- 2-1/2" vandal proof cross handle
- 3/8" - 18 NPT male thread shank assembly

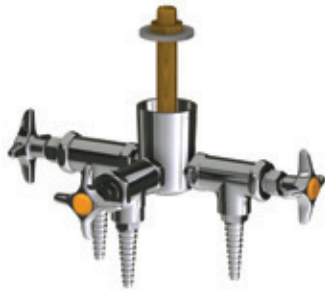

Index Button	Metal Handle		Plastic Handle	
	Straight Nozzle	30° Nozzle	Straight Nozzle	30° Nozzle
AIR	<b>LGF3-A11A-30</b>	LGF3-A21A-30	LGF3-A12A-30	LGF3-A22A-30
VAC	LGF3-A11B-30	LGF3-A21B-30	LGF3-A12B-30	LGF3-A22B-30
GAS	LGF3-A11C-30	LGF3-A21C-30	LGF3-A12C-30	LGF3-A22C-30
NIT	LGF3-A11D-30	LGF3-A21D-30	LGF3-A12D-30	LGF3-A22D-30
OXY	LGF3-A11E-30	LGF3-A21E-30	LGF3-A12E-30	LGF3-A22E-30
HE	LGF3-A11F-30	LGF3-A21F-30	LGF3-A12F-30	LGF3-A22F-30
CO2	LGF3-A11G-30	LGF3-A21G-30	LGF3-A12G-30	LGF3-A22G-30
CO	LGF3-A11H-30	LGF3-A21H-30	LGF3-A12H-30	LGF3-A22H-30
HYD	LGF3-A11I-30	LGF3-A21I-30	LGF3-A12I-30	LGF3-A22I-30
PRO	LGF3-A11J-30	LGF3-A21J-30	LGF3-A12J-30	LGF3-A22J-30
ACET	LGF3-A11K-30	LGF3-A21K-30	LGF3-A12K-30	LGF3-A22K-30
CH4	LGF3-A11L-30	LGF3-A21L-30	LGF3-A12L-30	LGF3-A22L-30
SG	LGF3-A11M-30	LGF3-A21M-30	LGF3-A12M-30	LGF3-A22M-30

## Overhead Mounted, Angle Pattern Four Gas Fine Control Needle Valve Assembly

- Solid brass turret with four outlets
- Solid brass angle valve body
- Polished chrome plated finish
- 2-1/2" vandal proof cross handle
- 3/8" - 18 NPT male thread shank assembly

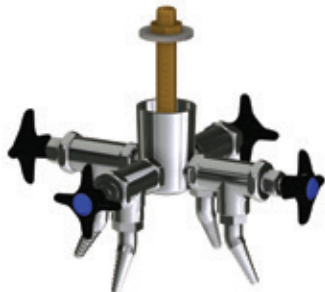

Index Button	Metal Handle		Plastic Handle	
	Straight Nozzle	30° Nozzle	Straight Nozzle	30° Nozzle
AIR	LGF3-A11A-40	LGF3-A21A-40	LGF3-A12A-40	LGF3-A22A-40
VAC	LGF3-A11B-40	LGF3-A21B-40	LGF3-A12B-40	LGF3-A22B-40
GAS	LGF3-A11C-40	LGF3-A21C-40	LGF3-A12C-40	<b>LGF3-A22C-40</b>
NIT	LGF3-A11D-40	LGF3-A21D-40	LGF3-A12D-40	LGF3-A22D-40
OXY	LGF3-A11E-40	LGF3-A21E-40	LGF3-A12E-40	LGF3-A22E-40
HE	LGF3-A11F-40	LGF3-A21F-40	LGF3-A12F-40	LGF3-A22F-40
CO2	LGF3-A11G-40	LGF3-A21G-40	LGF3-A12G-40	LGF3-A22G-40
CO	LGF3-A11H-40	LGF3-A21H-40	LGF3-A12H-40	LGF3-A22H-40
HYD	LGF3-A11I-40	LGF3-A21I-40	LGF3-A12I-40	LGF3-A22I-40
PRO	LGF3-A11J-40	LGF3-A21J-40	LGF3-A12J-40	LGF3-A22J-40
ACET	LGF3-A11K-40	LGF3-A21K-40	LGF3-A12K-40	LGF3-A22K-40
CH4	LGF3-A11L-40	LGF3-A21L-40	LGF3-A12L-40	LGF3-A22L-40
SG	LGF3-A11M-40	LGF3-A21M-40	LGF3-A12M-40	LGF3-A22M-40



## Wall Mounted, Straight Pattern Single Gas Fine Control Needle Valve Assembly Less Shank

- Wall flange
- Solid brass angle valve body
- Polished chrome plated finish
- 2-1/2" vandal proof cross handle
- 3/8" - 18 NPT female thread inlet



Index Button	Metal Handle		Plastic Handle	
	Straight Nozzle	30° Nozzle	Straight Nozzle	30° Nozzle
AIR	<b>LGF3-A11A-50</b>	LGF3-A21A-50	LGF3-A12A-50	LGF3-A22A-50
VAC	LGF3-A11B-50	LGF3-A21B-50	LGF3-A12B-50	LGF3-A22B-50
GAS	LGF3-A11C-50	LGF3-A21C-50	LGF3-A12C-50	LGF3-A22C-50
NIT	LGF3-A11D-50	LGF3-A21D-50	LGF3-A12D-50	LGF3-A22D-50
OXY	LGF3-A11E-50	LGF3-A21E-50	LGF3-A12E-50	LGF3-A22E-50
HE	LGF3-A11F-50	LGF3-A21F-50	LGF3-A12F-50	LGF3-A22F-50
CO2	LGF3-A11G-50	LGF3-A21G-50	LGF3-A12G-50	LGF3-A22G-50
CO	LGF3-A11H-50	LGF3-A21H-50	LGF3-A12H-50	LGF3-A22H-50
HYD	LGF3-A11I-50	LGF3-A21I-50	LGF3-A12I-50	LGF3-A22I-50
PRO	LGF3-A11J-50	LGF3-A21J-50	LGF3-A12J-50	LGF3-A22J-50
ACET	LGF3-A11K-50	LGF3-A21K-50	LGF3-A12K-50	LGF3-A22K-50
CH4	LGF3-A11L-50	LGF3-A21L-50	LGF3-A12L-50	LGF3-A22L-50
SG	LGF3-A11M-50	LGF3-A21M-50	LGF3-A12M-50	LGF3-A22M-50

## Wall Mounted, Straight Pattern Single Gas Fine Control Needle Valve Assembly With Shank

- Wall flange
- Solid brass angle valve body
- Polished chrome plated finish
- 2-1/2" vandal proof cross handle
- 3/8" - 18 NPT male thread shank assembly



Index Button	Metal Handle		Plastic Handle	
	Straight Nozzle	30° Nozzle	Straight Nozzle	30° Nozzle
AIR	LGF3-A11A-55	LGF3-A21A-55	LGF3-A12A-55	LGF3-A22A-55
VAC	LGF3-A11B-55	LGF3-A21B-55	LGF3-A12B-55	LGF3-A22B-55
GAS	LGF3-A11C-55	LGF3-A21C-55	LGF3-A12C-55	LGF3-A22C-55
NIT	LGF3-A11D-55	LGF3-A21D-55	LGF3-A12D-55	LGF3-A22D-55
OXY	LGF3-A11E-55	LGF3-A21E-55	LGF3-A12E-55	LGF3-A22E-55
HE	LGF3-A11F-55	LGF3-A21F-55	LGF3-A12F-55	LGF3-A22F-55
CO2	LGF3-A11G-55	LGF3-A21G-55	LGF3-A12G-55	LGF3-A22G-55
CO	LGF3-A11H-55	LGF3-A21H-55	LGF3-A12H-55	LGF3-A22H-55
HYD	LGF3-A11I-55	LGF3-A21I-55	LGF3-A12I-55	LGF3-A22I-55
PRO	LGF3-A11J-55	LGF3-A21J-55	LGF3-A12J-55	LGF3-A22J-55
ACET	LGF3-A11K-55	LGF3-A21K-55	LGF3-A12K-55	LGF3-A22K-55
CH4	LGF3-A11L-55	LGF3-A21L-55	LGF3-A12L-55	LGF3-A22L-55
SG	LGF3-A11M-55	LGF3-A21M-55	<b>LGF3-A12M-55</b>	LGF3-A22M-55

### Wall Mounted, “Y” Pattern Dual 90° Gas Fine Control Needle Valve Assembly Less Shank

- “Y” pattern wall flange with two valves at 90°
- Solid brass angle valve body
- Polished chrome plated finish
- 2-1/2” vandal proof cross handle
- 3/8” - 18 NPT female thread inlet



Index Button	Metal Handle		Plastic Handle	
	Straight Nozzle	30° Nozzle	Straight Nozzle	30° Nozzle
AIR	LGF3-A11A-60	LGF3-A21A-60	LGF3-A12A-60	LGF3-A22A-60
VAC	LGF3-A11B-60	<b>LGF3-A21B-60</b>	LGF3-A12B-60	LGF3-A22B-60
GAS	LGF3-A11C-60	LGF3-A21C-60	LGF3-A12C-60	LGF3-A22C-60
NIT	LGF3-A11D-60	LGF3-A21D-60	LGF3-A12D-60	LGF3-A22D-60
OXY	LGF3-A11E-60	LGF3-A21E-60	LGF3-A12E-60	LGF3-A22E-60
HE	LGF3-A11F-60	LGF3-A21F-60	LGF3-A12F-60	LGF3-A22F-60
CO2	LGF3-A11G-60	LGF3-A21G-60	LGF3-A12G-60	LGF3-A22G-60
CO	LGF3-A11H-60	LGF3-A21H-60	LGF3-A12H-60	LGF3-A22H-60
HYD	LGF3-A11I-60	LGF3-A21I-60	LGF3-A12I-60	LGF3-A22I-60
PRO	LGF3-A11J-60	LGF3-A21J-60	LGF3-A12J-60	LGF3-A22J-60
ACET	LGF3-A11K-60	LGF3-A21K-60	LGF3-A12K-60	LGF3-A22K-60
CH4	LGF3-A11L-60	LGF3-A21L-60	LGF3-A12L-60	LGF3-A22L-60
SG	LGF3-A11M-60	LGF3-A21M-60	LGF3-A12M-60	LGF3-A22M-60

### Wall Mounted, “Y” Pattern Dual 90° Gas Fine Control Needle Valve Assembly With Shank

- “Y” pattern wall flange with two valves at 90°
- Solid brass angle valve body
- Polished chrome plated finish
- 2-1/2” vandal proof cross handle
- 3/8” - 18 NPT male thread shank assembly



Index Button	Metal Handle		Plastic Handle	
	Straight Nozzle	30° Nozzle	Straight Nozzle	30° Nozzle
AIR	LGF3-A11A-65	LGF3-A21A-65	LGF3-A12A-65	LGF3-A22A-65
VAC	LGF3-A11B-65	LGF3-A21B-65	LGF3-A12B-65	LGF3-A22B-65
GAS	LGF3-A11C-65	LGF3-A21C-65	LGF3-A12C-65	<b>LGF3-A22C-65</b>
NIT	LGF3-A11D-65	LGF3-A21D-65	LGF3-A12D-65	LGF3-A22D-65
OXY	LGF3-A11E-65	LGF3-A21E-65	LGF3-A12E-65	LGF3-A22E-65
HE	LGF3-A11F-65	LGF3-A21F-65	LGF3-A12F-65	LGF3-A22F-65
CO2	LGF3-A11G-65	LGF3-A21G-65	LGF3-A12G-65	LGF3-A22G-65
CO	LGF3-A11H-65	LGF3-A21H-65	LGF3-A12H-65	LGF3-A22H-65
HYD	LGF3-A11I-65	LGF3-A21I-65	LGF3-A12I-65	LGF3-A22I-65
PRO	LGF3-A11J-65	LGF3-A21J-65	LGF3-A12J-65	LGF3-A22J-65
ACET	LGF3-A11K-65	LGF3-A21K-65	LGF3-A12K-65	LGF3-A22K-65
CH4	LGF3-A11L-65	LGF3-A21L-65	LGF3-A12L-65	LGF3-A22L-65
SG	LGF3-A11M-65	LGF3-A21M-65	LGF3-A12M-65	LGF3-A22M-65



## How to build and order a Chicago Faucets laboratory gas ball valve fitting.

Chicago Faucets makes it easy for you to build gas ball valve fittings that meet your exact requirements. You can reference the charts on the following pages, or you can build your own valve by choosing the components below to configure your model number.

# LGB A-B-C-D-E

(Lab Gas Ball Valve)

### Valve Base

A

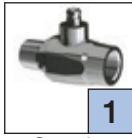

1  
Straight Valve

### Outlet

B

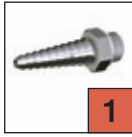

1  
Straight Nozzle



2  
30° Nozzle

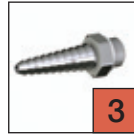

3  
Straight Nozzle w/ check valve

### Handle

C



1  
Metal Lever

### Button

D

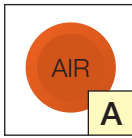

A  
Air

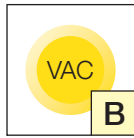

B  
Vacuum

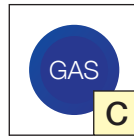

C  
Gas

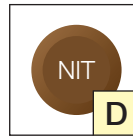

D  
Nitrogen

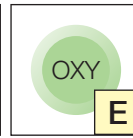

E  
Oxygen

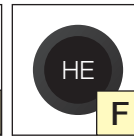

F  
Helium

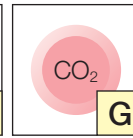

G  
Carbon Dioxide

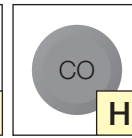

H  
Carbon Monoxide

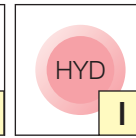

I  
Hydrogen

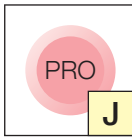

J  
Propane

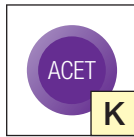

K  
Acetylene

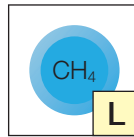

L  
Methane

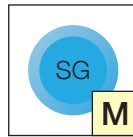

M  
Specialty Gas

### Turret

E



10  
Single



20  
Dual 90°



25  
Dual 180°



30  
Three Hole



40  
Four Hole



50  
Single Wall Flange

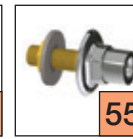

55  
Single Wall Flange with Shank

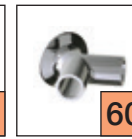

60  
Dual Wall Flange

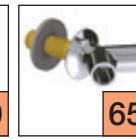

65  
Dual Wall Flange with Shank

### EXAMPLE



### LGB1-21A-10

Straight valve with a 30° nozzle, metal lever handle with AIR index button, and single hole turret.

## Straight Pattern Gas Ball Valve

- Solid brass straight valve body
- Polished chrome plated finish
- Metal lever handle with index button
- 3/8" - 18 NPT male thread inlet



Index Button	Straight Nozzle	30° Nozzle	Straight Nozzle w/ Check Valve
AIR	<b>LGB1-11A</b>	LGB1-21A	LGB1-31A
VAC	LGB1-11B	LGB1-21B	LGB1-31B
GAS	LGB1-11C	LGB1-21C	LGB1-31C
NIT	LGB1-11D	LGB1-21D	LGB1-31D
OXY	LGB1-11E	LGB1-21E	LGB1-31E
HE	LGB1-11F	LGB1-21F	LGB1-31F
CO2	LGB1-11G	LGB1-21G	LGB1-31G
CO	LGB1-11H	LGB1-21H	LGB1-31H
HYD	LGB1-11I	LGB1-21I	LGB1-31I
PRO	LGB1-11J	LGB1-21J	LGB1-31J
ACET	LGB1-11K	LGB1-21K	LGB1-31K
CH4	LGB1-11L	LGB1-21L	LGB1-31L
SG	LGB1-11M	LGB1-21M	LGB1-31M

## Deck Mounted, Straight Pattern Single Gas Ball Valve Assembly

- Solid brass turret with one outlet
- Solid brass straight valve body
- Polished chrome plated finish
- Metal lever handle with index button
- 3/8" - 18 NPT male thread shank assembly



Index Button	Straight Nozzle	30° Nozzle	Straight Nozzle w/ Check Valve
AIR	<b>LGB1-11A-10</b>	LGB1-21A-10	LGB1-31A-10
VAC	LGB1-11B-10	LGB1-21B-10	LGB1-31B-10
GAS	LGB1-11C-10	LGB1-21C-10	LGB1-31C-10
NIT	LGB1-11D-10	LGB1-21D-10	LGB1-31D-10
OXY	LGB1-11E-10	LGB1-21E-10	LGB1-31E-10
HE	LGB1-11F-10	LGB1-21F-10	LGB1-31F-10
CO2	LGB1-11G-10	LGB1-21G-10	LGB1-31G-10
CO	LGB1-11H-10	LGB1-21H-10	LGB1-31H-10
HYD	LGB1-11I-10	LGB1-21I-10	LGB1-31I-10
PRO	LGB1-11J-10	LGB1-21J-10	LGB1-31J-10
ACET	LGB1-11K-10	LGB1-21K-10	LGB1-31K-10
CH4	LGB1-11L-10	LGB1-21L-10	LGB1-31L-10
SG	LGB1-11M-10	LGB1-21M-10	LGB1-31M-10

### Deck Mounted, Straight Pattern Dual 90° Gas Ball Valve Assembly

- Solid brass turret with two 90° outlets
- Solid brass straight valve body
- Polished chrome plated finish
- Metal lever handle with index button
- 3/8" - 18 NPT male thread shank assembly



Index Button	Straight Nozzle	30° Nozzle	Straight Nozzle w/ Check Valve
AIR	<b>LGB1-11A-20</b>	LGB1-21A-20	LGB1-31A-20
VAC	LGB1-11B-20	LGB1-21B-20	LGB1-31B-20
GAS	LGB1-11C-20	LGB1-21C-20	LGB1-31C-20
NIT	LGB1-11D-20	LGB1-21D-20	LGB1-31D-20
OXY	LGB1-11E-20	LGB1-21E-20	LGB1-31E-20
HE	LGB1-11F-20	LGB1-21F-20	LGB1-31F-20
CO2	LGB1-11G-20	LGB1-21G-20	LGB1-31G-20
CO	LGB1-11H-20	LGB1-21H-20	LGB1-31H-20
HYD	LGB1-11I-20	LGB1-21I-20	LGB1-31I-20
PRO	LGB1-11J-20	LGB1-21J-20	LGB1-31J-20
ACET	LGB1-11K-20	LGB1-21K-20	LGB1-31K-20
CH4	LGB1-11L-20	LGB1-21L-20	LGB1-31L-20
SG	LGB1-11M-20	LGB1-21M-20	LGB1-31M-20

### Deck Mounted, Straight Pattern Dual 180° Gas Ball Valve Assembly

- Solid brass turret with two 180° outlets
- Solid brass straight valve body
- Polished chrome plated finish
- Metal lever handle with index button
- 3/8" - 18 NPT male thread shank assembly



Index Button	Straight Nozzle	30° Nozzle	Straight Nozzle w/ Check Valve
AIR	<b>LGB1-11A-25</b>	LGB1-21A-25	LGB1-31A-25
VAC	LGB1-11B-25	LGB1-21B-25	LGB1-31B-25
GAS	LGB1-11C-25	LGB1-21C-25	LGB1-31C-25
NIT	LGB1-11D-25	LGB1-21D-25	LGB1-31D-25
OXY	LGB1-11E-25	LGB1-21E-25	LGB1-31E-25
HE	LGB1-11F-25	LGB1-21F-25	LGB1-31F-25
CO2	LGB1-11G-25	LGB1-21G-25	LGB1-31G-25
CO	LGB1-11H-25	LGB1-21H-25	LGB1-31H-25
HYD	LGB1-11I-25	LGB1-21I-25	LGB1-31I-25
PRO	LGB1-11J-25	LGB1-21J-25	LGB1-31J-25
ACET	LGB1-11K-25	LGB1-21K-25	LGB1-31K-25
CH4	LGB1-11L-25	LGB1-21L-25	LGB1-31L-25
SG	LGB1-11M-25	LGB1-21M-25	LGB1-31M-25

## Deck Mounted, Straight Pattern Three Gas Ball Valve Assembly

- Solid brass turret with three outlets
- Solid brass straight valve body
- Polished chrome plated finish
- Metal lever handle with index button
- 3/8" - 18 NPT male thread shank assembly



Index Button	Straight Nozzle	30° Nozzle	Straight Nozzle w/ Check Valve
AIR	<b>LGB1-11A-30</b>	LGB1-21A-30	LGB1-31A-30
VAC	LGB1-11B-30	LGB1-21B-30	LGB1-31B-30
GAS	LGB1-11C-30	LGB1-21C-30	LGB1-31C-30
NIT	LGB1-11D-30	LGB1-21D-30	LGB1-31D-30
OXY	LGB1-11E-30	LGB1-21E-30	LGB1-31E-30
HE	LGB1-11F-30	LGB1-21F-30	LGB1-31F-30
CO2	LGB1-11G-30	LGB1-21G-30	LGB1-31G-30
CO	LGB1-11H-30	LGB1-21H-30	LGB1-31H-30
HYD	LGB1-11I-30	LGB1-21I-30	LGB1-31I-30
PRO	LGB1-11J-30	LGB1-21J-30	LGB1-31J-30
ACET	LGB1-11K-30	LGB1-21K-30	LGB1-31K-30
CH4	LGB1-11L-30	LGB1-21L-30	LGB1-31L-30
SG	LGB1-11M-30	LGB1-21M-30	LGB1-31M-30

## Deck Mounted, Straight Pattern Four Gas Ball Valve Assembly

- Solid brass turret with four outlets
- Solid brass straight valve body
- Polished chrome plated finish
- Metal lever handle with index button
- 3/8" - 18 NPT male thread shank assembly



Index Button	Straight Nozzle	30° Nozzle	Straight Nozzle w/ Check Valve
AIR	<b>LGB1-11A-40</b>	LGB1-21A-40	LGB1-31A-40
VAC	LGB1-11B-40	LGB1-21B-40	LGB1-31B-40
GAS	LGB1-11C-40	LGB1-21C-40	LGB1-31C-40
NIT	LGB1-11D-40	LGB1-21D-40	LGB1-31D-40
OXY	LGB1-11E-40	LGB1-21E-40	LGB1-31E-40
HE	LGB1-11F-40	LGB1-21F-40	LGB1-31F-40
CO2	LGB1-11G-40	LGB1-21G-40	LGB1-31G-40
CO	LGB1-11H-40	LGB1-21H-40	LGB1-31H-40
HYD	LGB1-11I-40	LGB1-21I-40	LGB1-31I-40
PRO	LGB1-11J-40	LGB1-21J-40	LGB1-31J-40
ACET	LGB1-11K-40	LGB1-21K-40	LGB1-31K-40
CH4	LGB1-11L-40	LGB1-21L-40	LGB1-31L-40
SG	LGB1-11M-40	LGB1-21M-40	LGB1-31M-40

## Wall Mounted, Straight Pattern Single Gas Ball Valve Assembly Less Shank

- Solid brass straight valve body
- Polished chrome plated finish
- Metal lever handle with index button
- 3/8" - 18 NPT female thread inlet
- Integral wall flange



Index Button	Straight Nozzle	30° Nozzle	Straight Nozzle w/ Check Valve
AIR	<b>LGB1-11A-50</b>	LGB1-21A-50	LGB1-31A-50
VAC	LGB1-11B-50	LGB1-21B-50	LGB1-31B-50
GAS	LGB1-11C-50	LGB1-21C-50	LGB1-31C-50
NIT	LGB1-11D-50	LGB1-21D-50	LGB1-31D-50
OXY	LGB1-11E-50	LGB1-21E-50	LGB1-31E-50
HE	LGB1-11F-50	LGB1-21F-50	LGB1-31F-50
CO2	LGB1-11G-50	LGB1-21G-50	LGB1-31G-50
CO	LGB1-11H-50	LGB1-21H-50	LGB1-31H-50
HYD	LGB1-11I-50	LGB1-21I-50	LGB1-31I-50
PRO	LGB1-11J-50	LGB1-21J-50	LGB1-31J-50
ACET	LGB1-11K-50	LGB1-21K-50	LGB1-31K-50
CH4	LGB1-11L-50	LGB1-21L-50	LGB1-31L-50
SG	LGB1-11M-50	LGB1-21M-50	LGB1-31M-50

## Wall Mounted, Straight Pattern Single Gas Ball Valve Assembly With Shank

- Solid brass straight valve body
- Polished chrome plated finish
- Metal lever handle with index button
- 3/8" - 18 NPT male thread shank assembly
- Integral wall flange



Index Button	Straight Nozzle	30° Nozzle	Straight Nozzle w/ Check Valve
AIR	<b>LGB1-11A-55</b>	LGB1-21A-55	LGB1-31A-55
VAC	LGB1-11B-55	LGB1-21B-55	LGB1-31B-55
GAS	LGB1-11C-55	LGB1-21C-55	LGB1-31C-55
NIT	LGB1-11D-55	LGB1-21D-55	LGB1-31D-55
OXY	LGB1-11E-55	LGB1-21E-55	LGB1-31E-55
HE	LGB1-11F-55	LGB1-21F-55	LGB1-31F-55
CO2	LGB1-11G-55	LGB1-21G-55	LGB1-31G-55
CO	LGB1-11H-55	LGB1-21H-55	LGB1-31H-55
HYD	LGB1-11I-55	LGB1-21I-55	LGB1-31I-55
PRO	LGB1-11J-55	LGB1-21J-55	LGB1-31J-55
ACET	LGB1-11K-55	LGB1-21K-55	LGB1-31K-55
CH4	LGB1-11L-55	LGB1-21L-55	LGB1-31L-55
SG	LGB1-11M-55	LGB1-21M-55	LGB1-31M-55



## Wall Mounted, “Y” Pattern Dual 90° Gas Ball Valve Assembly Less Shank

- “Y” pattern wall flange with two ball valves at 90°
- Solid brass straight valve body
- Polished chrome plated finish
- Metal lever handle with index button
- 3/8” - 18 NPT female thread inlet



Index Button	Straight Nozzle	30° Nozzle	Straight Nozzle w/ Check Valve
AIR	<b>LGB1-11A-60</b>	LGB1-21A-60	LGB1-31A-60
VAC	LGB1-11B-60	LGB1-21B-60	LGB1-31B-60
GAS	LGB1-11C-60	LGB1-21C-60	LGB1-31C-60
NIT	LGB1-11D-60	LGB1-21D-60	LGB1-31D-60
OXY	LGB1-11E-60	LGB1-21E-60	LGB1-31E-60
HE	LGB1-11F-60	LGB1-21F-60	LGB1-31F-60
CO2	LGB1-11G-60	LGB1-21G-60	LGB1-31G-60
CO	LGB1-11H-60	LGB1-21H-60	LGB1-31H-60
HYD	LGB1-11I-60	LGB1-21I-60	LGB1-31I-60
PRO	LGB1-11J-60	LGB1-21J-60	LGB1-31J-60
ACET	LGB1-11K-60	LGB1-21K-60	LGB1-31K-60
CH4	LGB1-11L-60	LGB1-21L-60	LGB1-31L-60
SG	LGB1-11M-60	LGB1-21M-60	LGB1-31M-60

## Wall Mounted, “Y” Pattern Dual 90° Gas Ball Valve Assembly With Shank

- “Y” pattern wall flange with two ball valves at 90°
- Solid brass straight valve body
- Polished chrome plated finish
- Metal lever handle with index button
- 3/8” - 18 NPT male thread shank assembly



Index Button	Straight Nozzle	30° Nozzle	Straight Nozzle w/ Check Valve
AIR	<b>LGB1-11A-65</b>	LGB1-21A-65	LGB1-31A-65
VAC	LGB1-11B-65	LGB1-21B-65	LGB1-31B-65
GAS	LGB1-11C-65	LGB1-21C-65	LGB1-31C-65
NIT	LGB1-11D-65	LGB1-21D-65	LGB1-31D-65
OXY	LGB1-11E-65	LGB1-21E-65	LGB1-31E-65
HE	LGB1-11F-65	LGB1-21F-65	LGB1-31F-65
CO2	LGB1-11G-65	LGB1-21G-65	LGB1-31G-65
CO	LGB1-11H-65	LGB1-21H-65	LGB1-31H-65
HYD	LGB1-11I-65	LGB1-21I-65	LGB1-31I-65
PRO	LGB1-11J-65	LGB1-21J-65	LGB1-31J-65
ACET	LGB1-11K-65	LGB1-21K-65	LGB1-31K-65
CH4	LGB1-11L-65	LGB1-21L-65	LGB1-31L-65
SG	LGB1-11M-65	LGB1-21M-65	LGB1-31M-65

### Polypropylene Pure Water Faucet

- 3/8" NPT polypropylene male thread inlet
- Choice of chrome or satin antimicrobial finish



Polished Chrome Finish	Deck Mount	Wall Mount
828-ACP	•	–
829-ACP	–	•
Satin Antimicrobial Finish		
828-ASAM	•	–

### Tygon Lined Pure Water Faucet

- 1/2" NPT male thread inlet
- Chrome plated finish
- Self-closing valve



Polished Chrome Finish	Deck Mount	Wall Mount
838-CP	•	–
839-ACP	–	•

### PVC Deck Mount Distilled Water Faucet

- 3/8" NPT female inlet or 1/2" NPSM male thread inlet
- Choice of right or left hand operation



Right Hand Operation
869-BPVC
Left Hand Operation
869-BLHPVC

### PVC Wall Mount Distilled Water Faucet

- 3/8" NPT female inlet or 1/2" NPSM male thread inlet



Polished Chrome Finish
870-BPCV

## Tin Lined Deck Mount Pure Water Faucet

- 1/4" NPT male thread inlet tail piece
- Faucet can be installed for right or left hand operation



Self-closing cartridge

Handle	Finish	
	Chrome	Satin Antimicrobial
Cross	969-CTF	969-SAM
4" Blade	969-317PLCTF	–

Slow compression cartridge

Handle	Chrome Finish
Cross	969-217XLHCTF

## Tin Lined Wall Mount Pure Water Faucet

- Gooseneck, straight, or angle valve
- Chrome plated finish
- Self-closing cartridge



Model	1/2" NPT Female Inlet	3/8" NPT Male Inlet	Integral Wall Flange	Handle
970-CTF	•	–	•	Right
971-CTF	–	•	–	Top
972-CTF	•	–	•	Top

## Natural PVDF Deck Mount Recirculating Water Faucet

- 3/8" NPT female inlet
- No metals, lubricants, elastomers used in design



Deck Mount
830-PVDF

## Natural PVDF Wall Mount Recirculating Water Faucet

- 3/8" NPT female inlet or 1/2" NPSM male thread inlet
- No metals, lubricants, elastomers used in design



Wall Mount
831-PVDF

## How to build and order a Chicago Faucets laboratory steam valve fitting.

Chicago Faucets makes it easy for you to build steam valve fittings that meet your exact requirements. You can reference the charts on the following pages, or you can build your own valve by choosing the components below to configure your model number.

**LSV** **A** - **B** **C** **D** - **E**  
 (Lab Steam Valve)

### Valve Base

**A**



Straight Valve



Angle Valve

### Cartridge

**B**



Compression

### Outlet

**C**



Straight Nozzle



30° Nozzle

### Handle

**D**

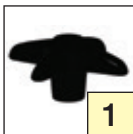

Plastic, "STM" Index

### Turret

**E**



Single



Dual 90°



Dual 180°



Three Hole



Four Hole



Single Wall Flange



Single Wall Flange with Shank



Dual Wall Flange



Dual Wall Flange with Shank

### EXAMPLE



### LSV1-A21-65

Straight valves with compression cartridges, 30° outlets, plastic handles with steam index buttons, and a dual wall flange with shank.

## Straight Pattern Steam Valve

- Solid brass valve body
- Polished chrome plated finish
- 2-1/2" vandal proof cross handle
- 3/8" - 18 NPT male thread inlet



Outlet	Model Number
Straight	LSV1-A11
30°	<b>LSV1-A21</b>

## Wall Mounted, Straight Pattern Dual 90° Steam Valve Assembly With Shank

- Turret with one outlet
- Solid brass valve body
- Polished chrome plated finish
- 2-1/2" vandal proof cross handle
- 3/8" - 18 NPT male thread shank assembly



Outlet	Model Number
Straight	<b>LSV1-A11-10</b>
30°	LSV1-A21-10

## Deck Mounted, Straight Pattern Dual 90° Steam Valve Assembly

- Turret with two 90° outlets
- Solid brass valve body
- Polished chrome plated finish
- 2-1/2" vandal proof cross handle
- 3/8" - 18 NPT male thread shank assembly



Outlet	Model Number
Straight	LSV1-A11-20
30°	<b>LSV1-A21-20</b>

## Deck Mounted, Straight Pattern Dual 180° Steam Valve Assembly

- Turret with two 180° outlets
- Solid brass valve body
- Polished chrome plated finish
- 2-1/2" vandal proof cross handle
- 3/8" - 18 NPT male thread shank assembly



Outlet	Model Number
Straight	<b>LSV1-A11-25</b>
30°	LSV1-A21-25

## Deck Mounted, Straight Pattern Three Steam Valve Assembly

- Turret with three outlets
- Solid brass valve body
- Polished chrome plated finish
- 2-1/2" vandal proof cross handle
- 3/8" - 18 NPT male thread shank assembly



Outlet	Model Number
Straight	<b>LSV1-A11-30</b>
30°	LSV1-A21-30

## Deck Mounted, Straight Pattern Four Steam Valve Assembly

- Turret with four outlets
- Solid brass valve body
- Polished chrome plated finish
- 2-1/2" vandal proof cross handle
- 3/8" - 18 NPT male thread shank assembly



Outlet	Model Number
Straight	LSV1-A11-40
30°	<b>LSV1-A21-40</b>

## Wall Mounted, Straight Pattern Single Steam Valve Assembly Less Shank

- Wall flange
- Solid brass valve body
- Polished chrome plated finish
- 2-1/2" vandal proof cross handle
- 3/8" - 18 NPT female thread inlet



Outlet	Model Number
Straight	<b>LSV1-A11-50</b>
30°	LSV1-A21-50

## Wall Mounted, Straight Pattern Single Steam Valve Assembly With Shank

- Wall flange with shank
- Solid brass valve body
- Polished chrome plated finish
- 2-1/2" vandal proof cross handle
- 3/8" - 18 NPT male thread shank assembly



Outlet	Model Number
Straight	LSV1-A11-55
30°	<b>LSV1-A21-55</b>

## Wall Mounted, Straight Pattern Dual 90° Steam Valve Assembly Less Shank

- Wall flange
- Solid brass valve body
- Polished chrome plated finish
- 2-1/2" vandal proof cross handle
- 3/8" - 18 NPT female thread inlet



Outlet	Model Number
Straight	LSV1-A11-60
30°	<b>LSV1-A21-60</b>

## Wall Mounted, Straight Pattern Dual 90° Steam Valve Assembly With Shank

- Wall flange with shank
- Solid brass valve body
- Polished chrome plated finish
- 2-1/2" vandal proof cross handle
- 3/8" - 18 NPT male thread shank assembly



Outlet	Model Number
Straight	<b>LSV1-A11-65</b>
30°	LSV1-A21-65

## Angle Pattern Steam Valve

- Solid brass valve body
- Polished chrome plated finish
- 2-1/2" vandal proof cross handle
- 3/8" - 18 NPT female thread inlet



Outlet	Model Number
Straight	<b>LSV2-A11</b>
30°	LSV2-A21

## Single Steam Valve Assembly, Overhead Mounted

- Turret with one outlet
- Solid brass valve body
- Polished chrome plated finish
- 2-1/2" vandal proof cross handle
- 3/8" - 18 NPT male thread shank assembly



Outlet	Model Number
Straight	LSV2-A11-10
30°	<b>LSV2-A21-10</b>

## Dual 90° Steam Valve Assembly, Overhead Mounted

- Turret with two 90° outlets
- Solid brass valve body
- Polished chrome plated finish
- 2-1/2" vandal proof cross handle
- 3/8" - 18 NPT male thread shank assembly



Outlet	Model Number
Straight	<b>LSV2-A11-20</b>
30°	LSV2-A21-20

## Dual 180° Steam Valve Assembly, Overhead Mounted

- Turret with two 180° outlets
- Solid brass valve body
- Polished chrome plated finish
- 2-1/2" vandal proof cross handle
- 3/8" - 18 NPT male thread shank assembly

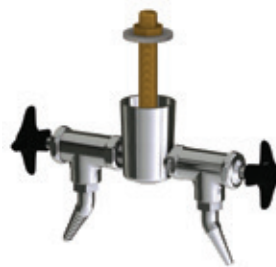

Outlet	Model Number
Straight	LSV2-A11-25
30°	<b>LSV2-A21-25</b>

## Three Steam Valve Assembly, Overhead Mounted

- Turret with three outlets
- Solid brass valve body
- Polished chrome plated finish
- 2-1/2" vandal proof cross handle
- 3/8" - 18 NPT male thread shank assembly

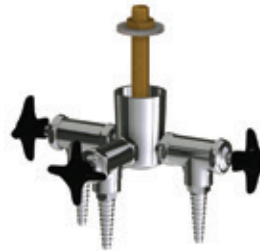

Outlet	Model Number
Straight	<b>LSV2-A11-30</b>
30°	LSV2-A21-30

## Four Steam Valve Assembly, Overhead Mounted

- Turret with four outlets
- Solid brass valve body
- Polished chrome plated finish
- 2-1/2" vandal proof cross handle
- 3/8" - 18 NPT male thread shank assembly



Outlet	Model Number
Straight	LSV2-A11-40
30°	<b>LSV2-A21-40</b>



## Wall Mounted, Angle Pattern Steam Valve with Single Wall Flange

- Wall flange
- Solid brass valve body
- Polished chrome plated finish
- 2-1/2" vandal proof cross handle
- 3/8" - 18 NPT female thread inlet



Outlet	Model Number
Straight	<b>LSV2-A11-50</b>
30°	LSV2-A21-50

## Wall Mounted, Angle Pattern Steam Valve with Single Wall Flange and Shank

- Wall flange with shank
- Solid brass valve body
- Polished chrome plated finish
- 2-1/2" vandal proof cross handle
- 3/8" - 18 NPT male thread shank assembly



Outlet	Model Number
Straight	LSV2-A11-55
30°	<b>LSV2-A21-55</b>

## Dual 180° Steam Valve Assembly, Wall Mounted

- Wall flange with two 180° outlets
- Solid brass valve body
- Polished chrome plated finish
- 2-1/2" vandal proof cross handle
- 3/8" - 18 NPT female thread inlet



Outlet	Model Number
Straight	<b>LSV2-A11-60</b>
30°	LSV2-A21-60

## Dual 180° Steam Valve Assembly With Shank, Wall Mounted

- Wall flange with two 180° outlets and shank
- Solid brass valve body
- Polished chrome plated finish
- 2-1/2" vandal proof cross handle
- 3/8" - 18 NPT male thread shank assembly



Outlet	Model Number
Straight	LSV2-A11-65
30°	<b>LSV2-A21-65</b>

## How to build and order a Chicago Faucets laboratory combination fitting with separate spout.

Chicago Faucets makes it easy for you to build combination fittings that meet your exact requirements. You can reference the charts on the following pages, or you can build your own valve by choosing the components below to configure your model number.

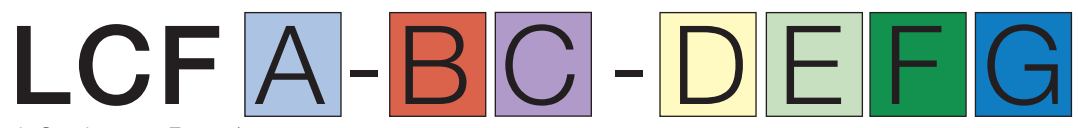

(Lab Combination Fittings)

### Valve Base

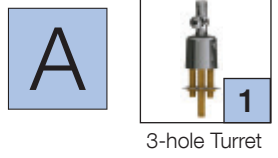

### Left Button

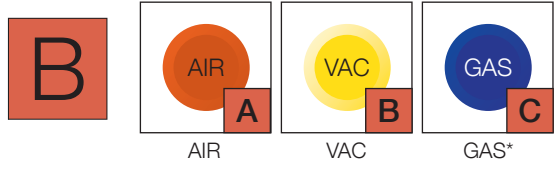

### Right Button

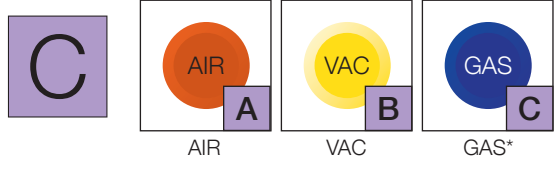

### Cartridge

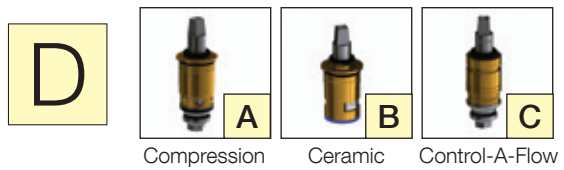

### Handle

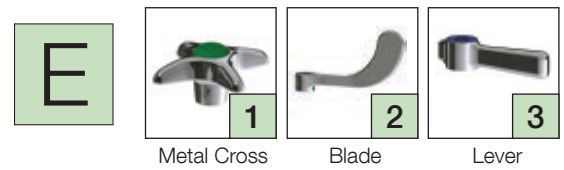

### Spout

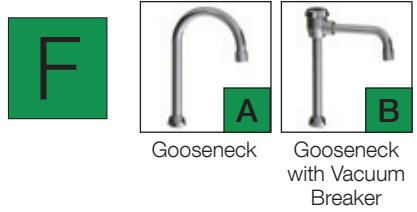

### Outlet

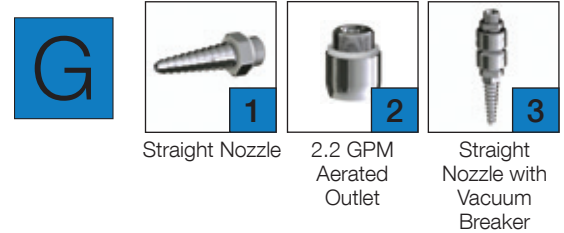

**EXAMPLE**

**LCF1-AB-A1A1**  
Triple-service fitting, air button on left valve, vacuum button on right valve, compression cartridge, cross handle, and gooseneck spout with straight nozzle.

\*Note: if gas service is selected, a check valve will automatically be included in the nozzle of the ball valve

## How to build and order a Chicago Faucets laboratory combination fitting with integrated spout.

Chicago Faucets makes it easy for you to build combination fittings that meet your exact requirements. You can reference the charts on the following pages, or you can build your own valve by choosing the components below to configure your model number.

# LCF A - B - C D E

(Lab Combination Fittings)

### Valve Base

A



3-hole Fitting

### Button (same for both handles)

B

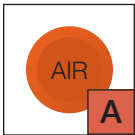

AIR

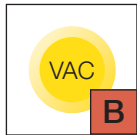

VAC

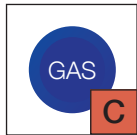

GAS\*

### Cartridge

C



Compression



Ceramic

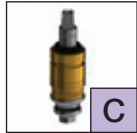

Control-A-Flow

### Outlet

E



Straight  
Nozzle



2.2 GPM  
Aerated  
Outlet



Straight  
Nozzle with  
Vacuum  
Breaker

### EXAMPLE



### LCF2-A-A13

Dual-service fitting, air buttons on valves, compression cartridge, metal cross handle and straight nozzle with vacuum breaker.

### Handle

D



Metal Cross

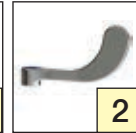

Blade

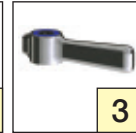

Lever

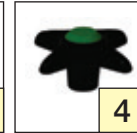

Plastic Cross

\*Note: if gas service is selected, a check valve will automatically be included in the nozzle of the ball valve

## Triple-service Combination Fitting with Gooseneck Spout and Cross Handle

- Turret with one top outlet for water and two side outlets for other services
- 5-1/4" gooseneck spout
- 7-5/8" water supply shank - 3/8"-18 NPT male inlet and 3/8"-18 NPT male outlet
- 5" gas supply shanks - 3/8"-18 NPT male inlet and 3/8"-18 NPT male outlet

Straight Nozzle on Spout



Index Buttons L/R	Gooseneck Spout			Gooseneck Spout w/ Vacuum Breaker		
	Compression Cartridge	Ceramic Cartridge	Control-A-Flow Cartridge	Compression Cartridge	Ceramic Cartridge	Control-A-Flow Cartridge
AIR/AIR	LCF1-AA-A1A1	LCF1-AA-B1A1	LCF1-AA-C1A1	LCF1-AA-A1B1	LCF1-AA-B1B1	LCF1-AA-C1B1
AIR/VAC	LCF1-AB-A1A1	LCF1-AB-B1A1	LCF1-AB-C1A1	LCF1-AB-A1B1	LCF1-AB-B1B1	LCF1-AB-C1B1
AIR/GAS	LCF1-AC-A1A1	<b>LCF1-AC-B1A1</b>	LCF1-AC-C1A1	LCF1-AC-A1B1	LCF1-AC-B1B1	LCF1-AC-C1B1
VAC/AIR	LCF1-BA-A1A1	LCF1-BA-B1A1	LCF1-BA-C1A1	LCF1-BA-A1B1	LCF1-BA-B1B1	LCF1-BA-C1B1
VAC/VAC	LCF1-BB-A1A1	LCF1-BB-B1A1	LCF1-BB-C1A1	LCF1-BB-A1B1	LCF1-BB-B1B1	LCF1-BB-C1B1
VAC/GAS	LCF1-BC-A1A1	LCF1-BC-B1A1	LCF1-BC-C1A1	LCF1-BC-A1B1	LCF1-BC-B1B1	LCF1-BC-C1B1
GAS/AIR	LCF1-CA-A1A1	LCF1-CA-B1A1	LCF1-CA-C1A1	LCF1-CA-A1B1	LCF1-CA-B1B1	LCF1-CA-C1B1
GAS/VAC	LCF1-CB-A1A1	LCF1-CB-B1A1	LCF1-CB-C1A1	LCF1-CB-A1B1	LCF1-CB-B1B1	LCF1-CB-C1B1
GAS/GAS	LCF1-CC-A1A1	LCF1-CC-B1A1	LCF1-CC-C1A1	LCF1-CC-A1B1	LCF1-CC-B1B1	LCF1-CC-C1B1

2.2 GPM Outlet on Spout



Index Buttons L/R	Gooseneck Spout			Gooseneck Spout w/ Vacuum Breaker		
	Compression Cartridge	Ceramic Cartridge	Control-A-Flow Cartridge	Compression Cartridge	Ceramic Cartridge	Control-A-Flow Cartridge
AIR/AIR	LCF1-AA-A2A2	LCF1-AA-B1A2	LCF1-AA-C1A2	<b>LCF1-AA-A1B2</b>	LCF1-AA-B1B2	LCF1-AA-C1B2
AIR/VAC	LCF1-AB-A2A2	LCF1-AB-B1A2	LCF1-AB-C1A2	LCF1-AB-A1B2	LCF1-AB-B1B2	LCF1-AB-C1B2
AIR/GAS	LCF1-AC-A2A2	LCF1-AC-B1A2	LCF1-AC-C1A2	LCF1-AC-A1B2	LCF1-AC-B1B2	LCF1-AC-C1B2
VAC/AIR	LCF1-BA-A2A2	LCF1-BA-B1A2	LCF1-BA-C1A2	LCF1-BA-A1B2	LCF1-BA-B1B2	LCF1-BA-C1B2
VAC/VAC	LCF1-BB-A2A2	LCF1-BB-B1A2	LCF1-BB-C1A2	LCF1-BB-A1B2	LCF1-BB-B1B2	LCF1-BB-C1B2
VAC/GAS	LCF1-BC-A2A2	LCF1-BC-B1A2	LCF1-BC-C1A2	LCF1-BC-A1B2	LCF1-BC-B1B2	LCF1-BC-C1B2
GAS/AIR	LCF1-CA-A2A2	LCF1-CA-B1A2	LCF1-CA-C1A2	LCF1-CA-A1B2	LCF1-CA-B1B2	LCF1-CA-C1B2
GAS/VAC	LCF1-CB-A2A2	LCF1-CB-B1A2	LCF1-CB-C1A2	LCF1-CB-A1B2	LCF1-CB-B1B2	LCF1-CB-C1B2
GAS/GAS	LCF1-CC-A2A2	LCF1-CC-B1A2	LCF1-CC-C1A2	LCF1-CC-A1B2	LCF1-CC-B1B2	LCF1-CC-C1B2

Straight Nozzle with Vacuum Breaker on Spout



Index Buttons L/R	Gooseneck Spout			Gooseneck Spout w/ Vacuum Breaker		
	Compression Cartridge	Ceramic Cartridge	Control-A-Flow Cartridge	Compression Cartridge	Ceramic Cartridge	Control-A-Flow Cartridge
AIR/AIR	LCF1-AA-A2A3	LCF1-AA-B1A3	LCF1-AA-C1A3	LCF1-AA-A1B3	LCF1-AA-B1B3	LCF1-AA-C1B3
AIR/VAC	LCF1-AB-A2A3	LCF1-AB-B1A3	LCF1-AB-C1A3	LCF1-AB-A1B3	LCF1-AB-B1B3	LCF1-AB-C1B3
AIR/GAS	LCF1-AC-A2A3	LCF1-AC-B1A3	LCF1-AC-C1A3	LCF1-AC-A1B3	LCF1-AC-B1B3	LCF1-AC-C1B3
VAC/AIR	LCF1-BA-A2A3	LCF1-BA-B1A3	LCF1-BA-C1A3	LCF1-BA-A1B3	LCF1-BA-B1B3	LCF1-BA-C1B3
VAC/VAC	LCF1-BB-A2A3	LCF1-BB-B1A3	LCF1-BB-C1A3	LCF1-BB-A1B3	LCF1-BB-B1B3	LCF1-BB-C1B3
VAC/GAS	LCF1-BC-A2A3	LCF1-BC-B1A3	LCF1-BC-C1A3	LCF1-BC-A1B3	LCF1-BC-B1B3	LCF1-BC-C1B3
GAS/AIR	LCF1-CA-A2A3	LCF1-CA-B1A3	LCF1-CA-C1A3	LCF1-CA-A1B3	LCF1-CA-B1B3	LCF1-CA-C1B3
GAS/VAC	LCF1-CB-A2A3	LCF1-CB-B1A3	LCF1-CB-C1A3	LCF1-CB-A1B3	LCF1-CB-B1B3	LCF1-CB-C1B3
GAS/GAS	LCF1-CC-A2A3	LCF1-CC-B1A3	<b>LCF1-CC-C1A3</b>	LCF1-CC-A1B3	LCF1-CC-B1B3	LCF1-CC-C1B3

## Triple-service Combination Fitting with Gooseneck Spout and Blade Handle

- Turret with one top outlet for water and two side outlets for other services
- 5-1/4" gooseneck spout
- 7-5/8" water supply shank - 3/8"-18 NPT male inlet and 3/8"-18 NPT male outlet
- 5" gas supply shanks - 3/8"-18 NPT male inlet and 3/8"-18 NPT male outlet

Straight Nozzle on Spout



Index Buttons L/R	Gooseneck Spout			Gooseneck Spout w/ Vacuum Breaker		
	Compression Cartridge	Ceramic Cartridge	Control-A-Flow Cartridge	Compression Cartridge	Ceramic Cartridge	Control-A-Flow Cartridge
AIR/AIR	LCF1-AA-A2A1	LCF1-AA-B2A1	LCF1-AA-C2A1	LCF1-AA-A2B1	LCF1-AA-B2B1	LCF1-AA-C2B1
AIR/VAC	LCF1-AB-A2A1	LCF1-AB-B2A1	LCF1-AB-C2A1	LCF1-AB-A2B1	LCF1-AB-B2B1	LCF1-AB-C2B1
AIR/GAS	LCF1-AC-A2A1	LCF1-AC-B2A1	LCF1-AC-C2A1	<b>LCF1-AC-A2B1</b>	LCF1-AC-B2B1	LCF1-AC-C2B1
VAC/AIR	LCF1-BA-A2A1	LCF1-BA-B2A1	LCF1-BA-C2A1	LCF1-BA-A2B1	LCF1-BA-B2B1	LCF1-BA-C2B1
VAC/VAC	LCF1-BB-A2A1	LCF1-BB-B2A1	LCF1-BB-C2A1	LCF1-BB-A2B1	LCF1-BB-B2B1	LCF1-BB-C2B1
VAC/GAS	LCF1-BC-A2A1	LCF1-BC-B2A1	LCF1-BC-C2A1	LCF1-BC-A2B1	LCF1-BC-B2B1	LCF1-BC-C2B1
GAS/AIR	LCF1-CA-A2A1	LCF1-CA-B2A1	LCF1-CA-C2A1	LCF1-CA-A2B1	LCF1-CA-B2B1	LCF1-CA-C2B1
GAS/VAC	LCF1-CB-A2A1	LCF1-CB-B2A1	LCF1-CB-C2A1	LCF1-CB-A2B1	LCF1-CB-B2B1	LCF1-CB-C2B1
GAS/GAS	LCF1-CC-A2A1	LCF1-CC-B2A1	LCF1-CC-C2A1	LCF1-CC-A2B1	LCF1-CC-B2B1	LCF1-CC-C2B1

2.2 GPM Outlet on Spout



Index Buttons L/R	Gooseneck Spout			Gooseneck Spout w/ Vacuum Breaker		
	Compression Cartridge	Ceramic Cartridge	Control-A-Flow Cartridge	Compression Cartridge	Ceramic Cartridge	Control-A-Flow Cartridge
AIR/AIR	LCF1-AA-A2A2	LCF1-AA-B2A2	LCF1-AA-C2A2	LCF1-AA-A1B2	LCF1-AA-B2B2	LCF1-AA-C2B2
AIR/VAC	LCF1-AB-A2A2	LCF1-AB-B2A2	LCF1-AB-C2A2	LCF1-AB-A1B2	LCF1-AB-B2B2	LCF1-AB-C2B2
AIR/GAS	LCF1-AC-A2A2	LCF1-AC-B2A2	LCF1-AC-C2A2	LCF1-AC-A1B2	LCF1-AC-B2B2	LCF1-AC-C2B2
VAC/AIR	LCF1-BA-A2A2	LCF1-BA-B2A2	LCF1-BA-C2A2	LCF1-BA-A1B2	LCF1-BA-B2B2	LCF1-BA-C2B2
VAC/VAC	LCF1-BB-A2A2	LCF1-BB-B2A2	LCF1-BB-C2A2	LCF1-BB-A1B2	LCF1-BB-B2B2	LCF1-BB-C2B2
VAC/GAS	LCF1-BC-A2A2	LCF1-BC-B2A2	LCF1-BC-C2A2	LCF1-BC-A1B2	LCF1-BC-B2B2	<b>LCF1-BC-C2B2</b>
GAS/AIR	LCF1-CA-A2A2	LCF1-CA-B2A2	LCF1-CA-C2A2	LCF1-CA-A1B2	LCF1-CA-B2B2	LCF1-CA-C2B2
GAS/VAC	LCF1-CB-A2A2	LCF1-CB-B2A2	LCF1-CB-C2A2	LCF1-CB-A1B2	LCF1-CB-B2B2	LCF1-CB-C2B2
GAS/GAS	LCF1-CC-A2A2	LCF1-CC-B2A2	LCF1-CC-C2A2	LCF1-CC-A1B2	LCF1-CC-B2B2	LCF1-CC-C2B2

Straight Nozzle with Vacuum Breaker on Spout



Index Buttons L/R	Gooseneck Spout			Gooseneck Spout w/ Vacuum Breaker		
	Compression Cartridge	Ceramic Cartridge	Control-A-Flow Cartridge	Compression Cartridge	Ceramic Cartridge	Control-A-Flow Cartridge
AIR/AIR	LCF1-AA-A2A3	LCF1-AA-B2A3	LCF1-AA-C2A3	LCF1-AA-A1B3	LCF1-AA-B2B3	LCF1-AA-C2B3
AIR/VAC	<b>LCF1-AB-A2A3</b>	LCF1-AB-B2A3	LCF1-AB-C2A3	LCF1-AB-A1B3	LCF1-AB-B2B3	LCF1-AB-C2B3
AIR/GAS	LCF1-AC-A2A3	LCF1-AC-B2A3	LCF1-AC-C2A3	LCF1-AC-A1B3	LCF1-AC-B2B3	LCF1-AC-C2B3
VAC/AIR	LCF1-BA-A2A3	LCF1-BA-B2A3	LCF1-BA-C2A3	LCF1-BA-A1B3	LCF1-BA-B2B3	LCF1-BA-C2B3
VAC/VAC	LCF1-BB-A2A3	LCF1-BB-B2A3	LCF1-BB-C2A3	LCF1-BB-A1B3	LCF1-BB-B2B3	LCF1-BB-C2B3
VAC/GAS	LCF1-BC-A2A3	LCF1-BC-B2A3	LCF1-BC-C2A3	LCF1-BC-A1B3	LCF1-BC-B2B3	LCF1-BC-C2B3
GAS/AIR	LCF1-CA-A2A3	LCF1-CA-B2A3	LCF1-CA-C2A3	LCF1-CA-A1B3	LCF1-CA-B2B3	LCF1-CA-C2B3
GAS/VAC	LCF1-CB-A2A3	LCF1-CB-B2A3	LCF1-CB-C2A3	LCF1-CB-A1B3	LCF1-CB-B2B3	LCF1-CB-C2B3
GAS/GAS	LCF1-CC-A2A3	LCF1-CC-B2A3	LCF1-CC-C2A3	LCF1-CC-A1B3	LCF1-CC-B2B3	LCF1-CC-C2B3

## Triple-service Combination Fitting with Gooseneck Spout and Lever Handle

- Turret with one top outlet for water and two side outlets for other services
- 5-1/4" gooseneck spout
- 7-5/8" water supply shank - 3/8"-18 NPT male inlet and 3/8"-18 NPT male outlet
- 5" gas supply shanks - 3/8"-18 NPT male inlet and 3/8"-18 NPT male outlet

Straight Nozzle on Spout



Index Buttons L/R	Gooseneck Spout			Gooseneck Spout w/ Vacuum Breaker		
	Compression Cartridge	Ceramic Cartridge	Control-A-Flow Cartridge	Compression Cartridge	Ceramic Cartridge	Control-A-Flow Cartridge
AIR/AIR	LCF1-AA-A3A1	LCF1-AA-B3A1	LCF1-AA-C3A1	LCF1-AA-A3B1	LCF1-AA-B3B1	LCF1-AA-C3B1
AIR/VAC	LCF1-AB-A3A1	LCF1-AB-B3A1	LCF1-AB-C3A1	LCF1-AB-A3B1	LCF1-AB-B3B1	LCF1-AB-C3B1
AIR/GAS	LCF1-AC-A3A1	LCF1-AC-B3A1	LCF1-AC-C3A1	LCF1-AC-A3B1	LCF1-AC-B3B1	LCF1-AC-C3B1
VAC/AIR	LCF1-BA-A3A1	LCF1-BA-B3A1	LCF1-BA-C3A1	LCF1-BA-A3B1	LCF1-BA-B3B1	LCF1-BA-C3B1
VAC/VAC	LCF1-BB-A3A1	LCF1-BB-B3A1	LCF1-BB-C3A1	LCF1-BB-A3B1	LCF1-BB-B3B1	LCF1-BB-C3B1
VAC/GAS	LCF1-BC-A3A1	LCF1-BC-B3A1	LCF1-BC-C3A1	LCF1-BC-A3B1	LCF1-BC-B3B1	LCF1-BC-C3B1
GAS/AIR	LCF1-CA-A3A1	LCF1-CA-B3A1	LCF1-CA-C3A1	LCF1-CA-A3B1	LCF1-CA-B3B1	LCF1-CA-C3B1
GAS/VAC	LCF1-CB-A3A1	LCF1-CB-B3A1	LCF1-CB-C3A1	LCF1-CB-A3B1	LCF1-CB-B3B1	LCF1-CB-C3B1
GAS/GAS	LCF1-CC-A3A1	LCF1-CC-B3A1	LCF1-CC-C3A1	<b>LCF1-CC-A3B1</b>	LCF1-CC-B3B1	LCF1-CC-C3B1

2.2 GPM Outlet on Spout



Index Buttons L/R	Gooseneck Spout			Gooseneck Spout w/ Vacuum Breaker		
	Compression Cartridge	Ceramic Cartridge	Control-A-Flow Cartridge	Compression Cartridge	Ceramic Cartridge	Control-A-Flow Cartridge
AIR/AIR	LCF1-AA-A3A2	LCF1-AA-B3A2	LCF1-AA-C3A2	LCF1-AA-A3B2	LCF1-AA-B3B2	LCF1-AA-C3B2
AIR/VAC	LCF1-AB-A3A2	LCF1-AB-B3A2	LCF1-AB-C3A2	LCF1-AB-A3B2	LCF1-AB-B3B2	LCF1-AB-C3B2
AIR/GAS	LCF1-AC-A3A2	LCF1-AC-B3A2	LCF1-AC-C3A2	LCF1-AC-A3B2	LCF1-AC-B3B2	LCF1-AC-C3B2
VAC/AIR	LCF1-BA-A3A2	LCF1-BA-B3A2	LCF1-BA-C3A2	LCF1-BA-A3B2	LCF1-BA-B3B2	LCF1-BA-C3B2
VAC/VAC	LCF1-BB-A3A2	LCF1-BB-B3A2	LCF1-BB-C3A2	LCF1-BB-A3B2	LCF1-BB-B3B2	LCF1-BB-C3B2
VAC/GAS	LCF1-BC-A3A2	LCF1-BC-B3A2	LCF1-BC-C3A2	LCF1-BC-A3B2	<b>LCF1-BC-B3B2</b>	LCF1-BC-C3B2
GAS/AIR	LCF1-CA-A3A2	LCF1-CA-B3A2	LCF1-CA-C3A2	LCF1-CA-A3B2	LCF1-CA-B3B2	LCF1-CA-C3B2
GAS/VAC	LCF1-CB-A3A2	LCF1-CB-B3A2	LCF1-CB-C3A2	LCF1-CB-A3B2	LCF1-CB-B3B2	LCF1-CB-C3B2
GAS/GAS	LCF1-CC-A3A2	LCF1-CC-B3A2	LCF1-CC-C3A2	LCF1-CC-A3B2	LCF1-CC-B3B2	LCF1-CC-C3B2

Straight Nozzle with Vacuum Breaker on Spout



Index Buttons L/R	Gooseneck Spout			Gooseneck Spout w/ Vacuum Breaker		
	Compression Cartridge	Ceramic Cartridge	Control-A-Flow Cartridge	Compression Cartridge	Ceramic Cartridge	Control-A-Flow Cartridge
AIR/AIR	LCF1-AA-A3A3	LCF1-AA-B3A3	LCF1-AA-C3A3	LCF1-AA-A3B3	LCF1-AA-B3B3	LCF1-AA-C3B3
AIR/VAC	LCF1-AB-A3A3	LCF1-AB-B3A3	LCF1-AB-C3A3	LCF1-AB-A3B3	LCF1-AB-B3B3	LCF1-AB-C3B3
AIR/GAS	LCF1-AC-A3A3	LCF1-AC-B3A3	LCF1-AC-C3A3	LCF1-AC-A3B3	LCF1-AC-B3B3	LCF1-AC-C3B3
VAC/AIR	LCF1-BA-A3A3	LCF1-BA-B3A3	LCF1-BA-C3A3	LCF1-BA-A3B3	LCF1-BA-B3B3	LCF1-BA-C3B3
VAC/VAC	LCF1-BB-A3A3	LCF1-BB-B3A3	LCF1-BB-C3A3	LCF1-BB-A3B3	LCF1-BB-B3B3	LCF1-BB-C3B3
VAC/GAS	LCF1-BC-A3A3	LCF1-BC-B3A3	LCF1-BC-C3A3	LCF1-BC-A3B3	LCF1-BC-B3B3	LCF1-BC-C3B3
GAS/AIR	LCF1-CA-A3A3	LCF1-CA-B3A3	LCF1-CA-C3A3	LCF1-CA-A3B3	LCF1-CA-B3B3	LCF1-CA-C3B3
GAS/VAC	LCF1-CB-A3A3	LCF1-CB-B3A3	<b>LCF1-CB-C3A3</b>	LCF1-CB-A3B3	LCF1-CB-B3B3	LCF1-CB-C3B3
GAS/GAS	LCF1-CC-A3A3	LCF1-CC-B3A3	LCF1-CC-C3A3	LCF1-CC-A3B3	LCF1-CC-B3B3	LCF1-CC-C3B3

## Dual-service Combination Fitting with Integrated Spout and Metal Cross Handle

- One-piece spout design with one top and two side outlets
- 2-1/4", 3/8" NPT male front shank for water
- 2-1/4", 3/8" NPT male rear shank for other services



Straight Nozzle on Spout

Index Buttons	Integrated Spout		
	Compression Cartridge	Ceramic Cartridge	Control-A-Flow Cartridge
AIR	<b>LCF2-A-A11</b>	LCF2-A-B11	LCF2-A-C11
VAC	LCF2-B-A11	LCF2-B-B11	LCF2-B-C11
GAS	LCF2-C-A11	LCF2-C-B11	LCF2-C-C11



2.2 GPM Outlet on Spout

Index Buttons	Integrated Spout		
	Compression Cartridge	Ceramic Cartridge	Control-A-Flow Cartridge
AIR	LCF2-A-A12	LCF2-A-B12	LCF2-A-C12
VAC	LCF2-B-A12	<b>LCF2-B-B12</b>	LCF2-B-C12
GAS	LCF2-C-A12	LCF2-C-B12	LCF2-C-C12



Straight Nozzle with Vacuum Breaker on Spout

Index Buttons	Integrated Spout		
	Compression Cartridge	Ceramic Cartridge	Control-A-Flow Cartridge
AIR	LCF2-A-A13	LCF2-A-B13	LCF2-A-C13
VAC	LCF2-B-A13	LCF2-B-B13	LCF2-B-C13
GAS	LCF2-C-A13	LCF2-C-B13	<b>LCF2-C-C13</b>

## Dual-service Combination Fitting with Integrated Spout and Blade Handle

- One-piece spout design with one top and two side outlets
- 2-1/4", 3/8" NPT male front shank for water
- 2-1/4", 3/8" NPT male rear shank for other services



Straight Nozzle on Spout

Index Buttons	Integrated Spout		
	Compression Cartridge	Ceramic Cartridge	Control-A-Flow Cartridge
AIR	LCF2-A-A21	LCF2-A-B21	LCF2-A-C21
VAC	<b>LCF2-B-A21</b>	LCF2-B-B21	LCF2-B-C21
GAS	LCF2-C-A21	LCF2-C-B21	LCF2-C-C21



2.2 GPM Outlet on Spout

Index Buttons	Integrated Spout		
	Compression Cartridge	Ceramic Cartridge	Control-A-Flow Cartridge
AIR	LCF2-A-A22	LCF2-A-B22	LCF2-A-C22
VAC	LCF2-B-A22	LCF2-B-B22	LCF2-B-C22
GAS	LCF2-C-A22	LCF2-C-B22	<b>LCF2-C-C22</b>



Straight Nozzle with Vacuum Breaker on Spout

Index Buttons	Integrated Spout		
	Compression Cartridge	Ceramic Cartridge	Control-A-Flow Cartridge
AIR	LCF2-A-A23	<b>LCF2-A-B23</b>	LCF2-A-C23
VAC	LCF2-B-A23	LCF2-B-B23	LCF2-B-C23
GAS	LCF2-C-A23	LCF2-C-B23	LCF2-C-C23



## Dual-service Combination Fitting with Integrated Spout and Lever Handle

- One-piece spout design with one top and two side outlets
- 2-1/4", 3/8" NPT male front shank for water
- 2-1/4", 3/8" NPT male rear shank for other services



Straight Nozzle on Spout

Index Buttons	Integrated Spout		
	Compression Cartridge	Ceramic Cartridge	Control-A-Flow Cartridge
AIR	LCF2-A-A31	LCF2-A-B31	LCF2-A-C31
VAC	LCF2-B-A31	LCF2-B-B31	LCF2-B-C31
GAS	LCF2-C-A31	LCF2-C-B31	<b>LCF2-C-C31</b>



2.2 GPM Outlet on Spout

Index Buttons	Integrated Spout		
	Compression Cartridge	Ceramic Cartridge	Control-A-Flow Cartridge
AIR	<b>LCF2-A-A32</b>	LCF2-A-B32	LCF2-A-C32
VAC	LCF2-B-A32	LCF2-B-B32	LCF2-B-C32
GAS	LCF2-C-A32	LCF2-C-B32	LCF2-C-C32



Straight Nozzle with Vacuum Breaker on Spout

Index Buttons	Integrated Spout		
	Compression Cartridge	Ceramic Cartridge	Control-A-Flow Cartridge
AIR	LCF2-A-A33	LCF2-A-B33	LCF2-A-C33
VAC	LCF2-B-A33	<b>LCF2-B-B33</b>	LCF2-B-C33
GAS	LCF2-C-A33	LCF2-C-B33	LCF2-C-C33

## Dual-service Combination Fitting with Integrated Spout and Plastic Cross Handle

- One-piece spout design with one top and two side outlets
- 2-1/4", 3/8" NPT male front shank for water
- 2-1/4", 3/8" NPT male rear shank for other services



Straight Nozzle on Spout

Index Buttons	Integrated Spout		
	Compression Cartridge	Ceramic Cartridge	Control-A-Flow Cartridge
AIR	LCF2-A-A41	LCF2-A-B41	<b>LCF2-A-C41</b>
VAC	LCF2-B-A41	LCF2-B-B41	LCF2-B-C41
GAS	LCF2-C-A41	LCF2-C-B41	LCF2-C-C41



2.2 GPM Outlet on Spout

Index Buttons	Integrated Spout		
	Compression Cartridge	Ceramic Cartridge	Control-A-Flow Cartridge
AIR	LCF2-A-A42	LCF2-A-B42	LCF2-A-C42
VAC	LCF2-B-A42	<b>LCF2-B-B42</b>	LCF2-B-C42
GAS	LCF2-C-A42	LCF2-C-B42	LCF2-C-C42



Straight Nozzle with Vacuum Breaker on Spout

Index Buttons	Integrated Spout		
	Compression Cartridge	Ceramic Cartridge	Control-A-Flow Cartridge
AIR	LCF2-A-A43	LCF2-A-B43	LCF2-A-C43
VAC	LCF2-B-A43	LCF2-B-B43	LCF2-B-C43
GAS	<b>LCF2-C-A43</b>	LCF2-C-B43	LCF2-C-C43



## How to build and order a Chicago Faucets laboratory remote spout.



















Chicago Faucets makes it easy for you to build remote spouts that meet your exact requirements. You can reference the charts on the following pages or you can build your own fitting by using the chart below to configure your model number.

**LRS-** **Base** (A,B,C,D or E) **Outlet** (01,02,11,12) **Finish** (no code required for chrome)











**EXAMPLE**



**LRS-A01-DGR**  
Straight base with straight nozzle in a dark green finish.

		Base Options				
Outlet Options		A	B	C	D	E
01						
02						
11						
21						

**Finish Options**

										
White	Yellow	Orange	Dark Green	Red	Dark Blue	Light Blue	Light Green	Brown	Pink	Black

## Panel Mount Straight Base, Straight Nozzle

- Solid brass straight fitting base
- Choice of finishes
- 3/8" - 18 NPT male thread shank assembly

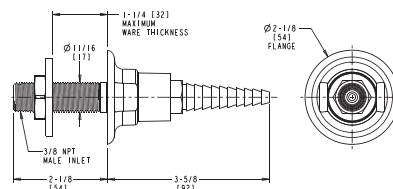

Finish	Model Number
Chrome	<b>LRS-A01</b>
White	LRS-A01-WHT
Yellow	LRS-A01-YEL
Orange	LRS-A01-ORG
Dark Green	LRS-A01-DGR
Red	LRS-A01-RED
Dark Blue	LRS-A01-DBL
Light Blue	LRS-A01-LBL
Light Green	LRS-A01-LGR
Brown	LRS-A01-BRN
Pink	LRS-A01-PNK
Black	LRS-A01-BLK

## Panel Mount Straight Base, 30° Nozzle

- Solid brass straight fitting base
- Choice of finishes
- 3/8" - 18 NPT male thread shank assembly

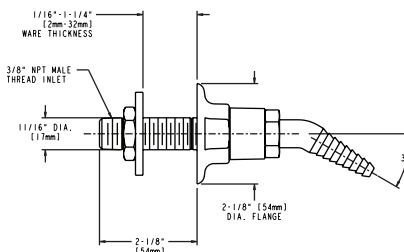

Finish	Model Number
Chrome	<b>LRS-A02</b>
White	LRS-A02-WHT
Yellow	LRS-A02-YEL
Orange	LRS-A02-ORG
Dark Green	LRS-A02-DGR
Red	LRS-A02-RED
Dark Blue	LRS-A02-DBL
Light Blue	LRS-A02-LBL
Light Green	LRS-A02-LGR
Brown	LRS-A02-BRN
Pink	LRS-A02-PNK
Black	LRS-A02-BLK

## Panel Mount Angle Base with Extension, Straight Nozzle

- Solid brass angle fitting with extension
- Choice of finishes
- 3/8" - 18 NPT male thread shank assembly

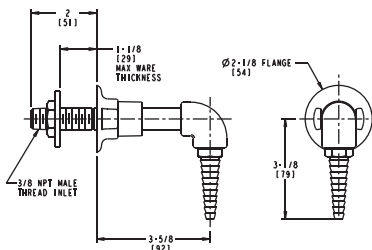

Finish	Model Number
Chrome	<b>LRS-B01</b>
White	LRS-B01-WHT
Yellow	LRS-B01-YEL
Orange	LRS-B01-ORG
Dark Green	LRS-B01-DGR
Red	LRS-B01-RED
Dark Blue	LRS-B01-DBL
Light Blue	LRS-B01-LBL
Light Green	LRS-B01-LGR
Brown	LRS-B01-BRN
Pink	LRS-B01-PNK
Black	LRS-B01-BLK

## Panel Mount Angle Base with Extension, 30° Nozzle

- Solid brass angle fitting with extension
- Choice of finishes
- 3/8" - 18 NPT male thread shank assembly

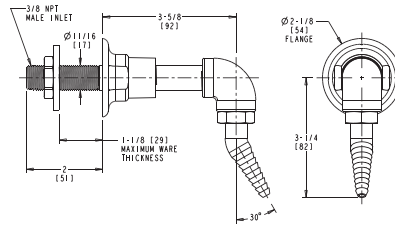

Finish	Model Number
Chrome	<b>LRS-B02</b>
White	LRS-B02-WHT
Yellow	LRS-B02-YEL
Orange	LRS-B02-ORG
Dark Green	LRS-B02-DGR
Red	LRS-B02-RED
Dark Blue	LRS-B02-DBL
Light Blue	LRS-B02-LBL
Light Green	LRS-B02-LGR
Brown	LRS-B02-BRN
Pink	LRS-B02-PNK
Black	LRS-B02-BLK

## Panel Mount Angle Base, Straight Nozzle

- Solid brass angle fitting base
- Choice of finishes
- 3/8" - 18 NPT male thread shank assembly

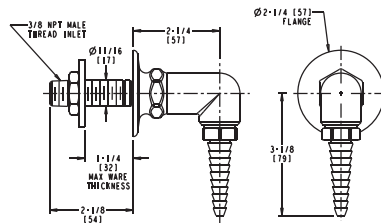

Finish	Model Number
Chrome	<b>LRS-C01</b>
White	LRS-C01-WHT
Yellow	LRS-C01-YEL
Orange	LRS-C01-ORG
Dark Green	LRS-C01-DGR
Red	LRS-C01-RED
Dark Blue	LRS-C01-DBL
Light Blue	LRS-C01-LBL
Light Green	LRS-C01-LGR
Brown	LRS-C01-BRN
Pink	LRS-C01-PNK
Black	LRS-C01-BLK

## Panel Mount Angle Base, 30° Nozzle

- Solid brass angle fitting base
- Choice of finishes
- 3/8" - 18 NPT male thread shank assembly

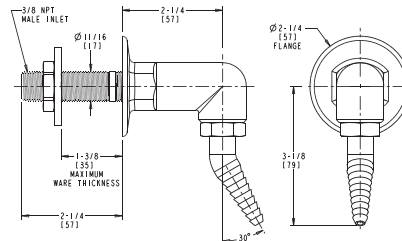

Finish	Model Number
Chrome	<b>LRS-C02</b>
White	LRS-C02-WHT
Yellow	LRS-C02-YEL
Orange	LRS-C02-ORG
Dark Green	LRS-C02-DGR
Red	LRS-C02-RED
Dark Blue	LRS-C02-DBL
Light Blue	LRS-C02-LBL
Light Green	LRS-C02-LGR
Brown	LRS-C02-BRN
Pink	LRS-C02-PNK
Black	LRS-C02-BLK

## Deck Mount Turret Base, Straight Nozzle

- Solid brass turret base
- Choice of finishes
- 3/8" - 18 NPT male thread shank assembly

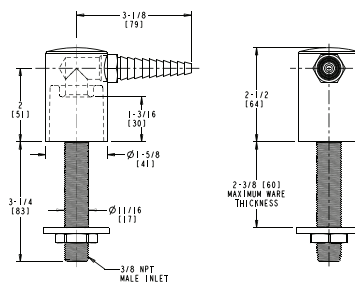

Finish	Model Number
Chrome	<b>LRS-D01</b>
White	LRS-D01-WHT
Yellow	LRS-D01-YEL
Orange	LRS-D01-ORG
Dark Green	LRS-D01-DGR
Red	LRS-D01-RED
Dark Blue	LRS-D01-DBL
Light Blue	LRS-D01-LBL
Light Green	LRS-D01-LGR
Brown	LRS-D01-BRN
Pink	LRS-D01-PNK
Black	LRS-D01-BLK

## Deck Mount Turret Base, 30° Nozzle

- Solid brass turret base
- Choice of finishes
- 3/8" - 18 NPT male thread shank assembly

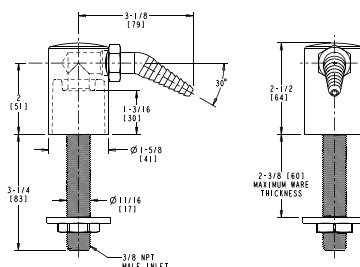

Finish	Model Number
Chrome	<b>LRS-D02</b>
White	LRS-D02-WHT
Yellow	LRS-D02-YEL
Orange	LRS-D02-ORG
Dark Green	LRS-D02-DGR
Red	LRS-D02-RED
Dark Blue	LRS-D02-DBL
Light Blue	LRS-D02-LBL
Light Green	LRS-D02-LGR
Brown	LRS-D02-BRN
Pink	LRS-D02-PNK
Black	LRS-D02-BLK

## Panel Mount Angle Base with Gooseneck Spout

- Solid brass angle fitting base
- 5-1/4" rigid/swing gooseneck spout
- Choice of finishes
- 3/8" - 18 NPT male thread shank assembly

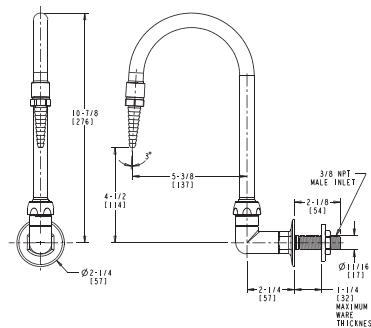

Finish	Model Number
Chrome	<b>LRS-C11</b>
White	LRS-C11-WHT
Yellow	LRS-C11-YEL
Orange	LRS-C11-ORG
Dark Green	LRS-C11-DGR
Red	LRS-C11-RED
Dark Blue	LRS-C11-DBL
Light Blue	LRS-C11-LBL
Light Green	LRS-C11-LGR
Brown	LRS-C11-BRN
Pink	LRS-C11-PNK
Black	LRS-C11-BLK

## Panel Mount Angle Base with Gooseneck Spout

- Solid brass angle fitting base
- 6" rigid/swing gooseneck spout with vacuum breaker
- Choice of finishes
- 3/8" - 18 NPT male thread shank assembly

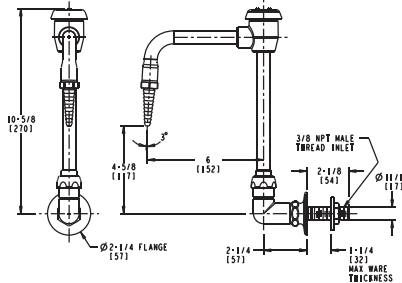

Finish	Model Number
Chrome	<b>LRS-C21</b>
White	LRS-C21-WHT
Yellow	LRS-C21-YEL
Orange	LRS-C21-ORG
Dark Green	LRS-C21-DGR
Red	LRS-C21-RED
Dark Blue	LRS-C21-DBL
Light Blue	LRS-C21-LBL
Light Green	LRS-C21-LGR
Brown	LRS-C21-BRN
Pink	LRS-C21-PNK
Black	LRS-C21-BLK

## Panel Mount Turret Base with Gooseneck Spout

- Solid brass turret base
- 5-1/4" rigid/swing gooseneck spout
- Choice of finishes
- 3/8" - 18 NPT male thread shank assembly

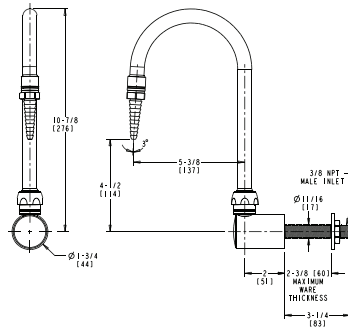

Finish	Model Number
Chrome	<b>LRS-D11</b>
White	LRS-D11-WHT
Yellow	LRS-D11-YEL
Orange	LRS-D11-ORG
Dark Green	LRS-D11-DGR
Red	LRS-D11-RED
Dark Blue	LRS-D11-DBL
Light Blue	LRS-D11-LBL
Light Green	LRS-D11-LGR
Brown	LRS-D11-BRN
Pink	LRS-D11-PNK
Black	LRS-D11-BLK

## Panel Mount Turret Base with Gooseneck Spout

- Solid brass turret base
- 6" rigid/swing gooseneck spout with vacuum breaker
- Choice of finishes
- 3/8" - 18 NPT male thread shank assembly

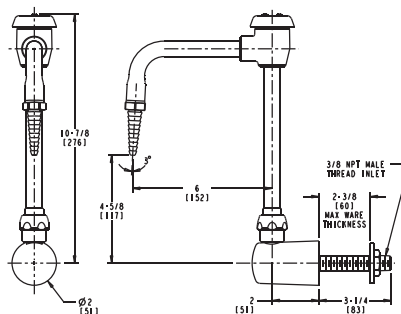

Finish	Model Number
Chrome	<b>LRS-D21</b>
White	LRS-D21-WHT
Yellow	LRS-D21-YEL
Orange	LRS-D21-ORG
Dark Green	LRS-D21-DGR
Red	LRS-D21-RED
Dark Blue	LRS-D21-DBL
Light Blue	LRS-D21-LBL
Light Green	LRS-D21-LGR
Brown	LRS-D21-BRN
Pink	LRS-D21-PNK
Black	LRS-D21-BLK



## Deck Mount Turret Base with Gooseneck Spout

- Solid brass turret base
- 5-1/4" rigid/swing gooseneck spout
- Choice of finishes
- 3/8" - 18 NPT male thread shank assembly

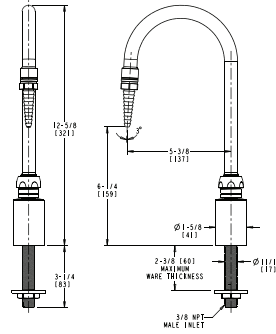

Finish	Model Number
Chrome	<b>LRS-E11</b>
White	LRS-E11-WHT
Yellow	LRS-E11-YEL
Orange	LRS-E11-ORG
Dark Green	LRS-E11-DGR
Red	LRS-E11-RED
Dark Blue	LRS-E11-DBL
Light Blue	LRS-E11-LBL
Light Green	LRS-E11-LGR
Brown	LRS-E11-BRN
Pink	LRS-E11-PNK
Black	LRS-E11-BLK

## Deck Mount Turret Base with Gooseneck Spout

- Forged brass turret base
- 6" rigid/swing gooseneck spout with vacuum breaker
- Choice of finishes
- 3/8" - 18 NPT male thread shank assembly

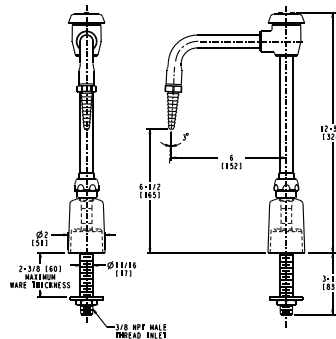

Finish	Model Number
Chrome	<b>LRS-E21</b>
White	LRS-E21-WHT
Yellow	LRS-E21-YEL
Orange	LRS-E21-ORG
Dark Green	LRS-E21-DGR
Red	LRS-E21-RED
Dark Blue	LRS-E21-DBL
Light Blue	LRS-E21-LBL
Light Green	LRS-E21-LGR
Brown	LRS-E21-BRN
Pink	LRS-E21-PNK
Black	LRS-E21-BLK

## How to build and order a Chicago Faucets laboratory water remote valve.

Chicago Faucets makes it easy for you to build remote valves that meet your exact requirements. You can reference the charts on the following pages or you can build your own fitting by using the chart below to configure your model number.







**LRV-W** A - B C D  
 (Lab Remote Valve - Water)

**EXAMPLE**



**LRV-W2-A1A**  
 Water valve with left hand 45° angle base, compression cartridges, metal cross handle with cold index button.

### Base

A	 <span style="background-color: #e67e22; color: white; padding: 2px 5px;">1</span>	 <span style="background-color: #e67e22; color: white; padding: 2px 5px;">2</span>	 <span style="background-color: #e67e22; color: white; padding: 2px 5px;">3</span>	 <span style="background-color: #e67e22; color: white; padding: 2px 5px;">4</span>	 <span style="background-color: #e67e22; color: white; padding: 2px 5px;">5</span>	 <span style="background-color: #e67e22; color: white; padding: 2px 5px;">6</span>
	RH 45° Angle	LH 45° Angle	Concealed Valve with Escutcheon	Concealed Valve	Angle Valve for Straight Panels	Angle Valve for 45° Angle Panels

### Cartridge

B	 <span style="background-color: #27ae60; color: white; padding: 2px 5px;">A</span>
	Compression

### Handle

C	 <span style="background-color: #f1c40f; color: white; padding: 2px 5px;">1</span>	 <span style="background-color: #f1c40f; color: white; padding: 2px 5px;">2</span>
	Metal Cross	Plastic Cross

### Button

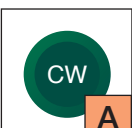
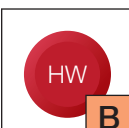
D	 <span style="background-color: #e67e22; color: white; padding: 2px 5px;">A</span>	 <span style="background-color: #e67e22; color: white; padding: 2px 5px;">B</span>
	Plastic, "CW" Index	Plastic, "HW" Index

## How to build and order a Chicago Faucets laboratory steam remote valve.

Chicago Faucets makes it easy for you to build remote valves that meet your exact requirements. You can reference the charts on the following pages or you can build your own fitting by using the chart below to configure your model number.

**LRV-S** A - B C D  
 (Lab Remote Valve - Steam)

**EXAMPLE**



**LRV-S2-A1A**  
 Steam valve with left hand 45° angle base, compression cartridges, plastic cross handle with steam index button.

### Base

A



RH 45° Angle



LH 45° Angle



Concealed Valve

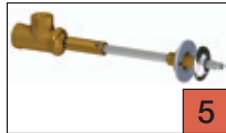

Angle Valve for Straight Panels

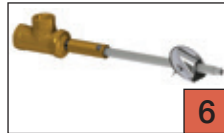

Angle Valve for 45° Angle Panels

### Cartridge

B

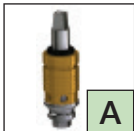

Slow Compression Steam

### Handle

C

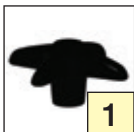

Plastic Cross

### Button

D

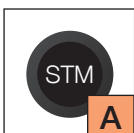

Plastic, "STM" Index

## How to build and order a Chicago Faucets laboratory remote needle valve.

Chicago Faucets makes it easy for you to build remote valves that meet your exact requirements. You can reference the charts on the following pages or you can build your own fitting by using the chart below to configure your model number.

**LRV-N** A - B C D

(Lab Remote Valve - Needle)





**EXAMPLE**



**LRV-N2-A1D**  
Needle valve with left hand 45° angle base, compression cartridge, metal cross handle with NIT index button.

### Base

A

 <b>1</b>	 <b>2</b>	 <b>4</b>	 <b>5</b>	 <b>6</b>
RH 45° Angle	LH 45° Angle	Concealed Valve	Angle Valve for Straight Panels	Angle Valve for 45° Angle Panels

### Cartridge

B

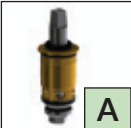
 <b>A</b>
Needle Compression

### Handle

C

 <b>1</b>	 <b>2</b>
Metal Cross	Plastic Cross

### Button

D

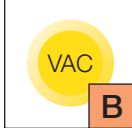
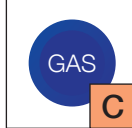
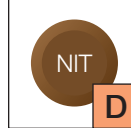
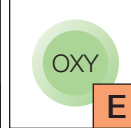
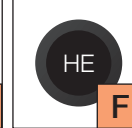
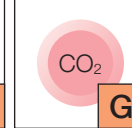
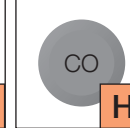
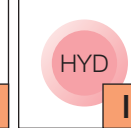
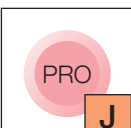
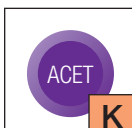
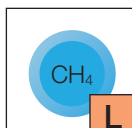
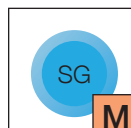
 <b>A</b>	 <b>B</b>	 <b>C</b>	 <b>D</b>	 <b>E</b>	 <b>F</b>	 <b>G</b>	 <b>H</b>	 <b>I</b>
Plastic, "AIR" Index	Plastic, "VAC" Index	Plastic, "GAS" Index	Plastic, "NIT" Index	Plastic, "OXY" Index	Plastic, "HE" Index	Plastic, "CO <sub>2</sub> " Index	Plastic, "CO" Index	Plastic, "HYD" Index
 <b>J</b>	 <b>K</b>	 <b>L</b>	 <b>M</b>					
Plastic, "PRO" Index	Plastic, "ACET" Index	Plastic, "CH <sub>4</sub> " Index	Plastic, "SG" Index					

## How to build and order a Chicago Faucets laboratory remote fine needle valve.

Chicago Faucets makes it easy for you to build remote valves that meet your exact requirements. You can reference the charts on the following pages or you can build your own fitting by using the chart below to configure your model number.

**LRV-F** A - B C D  
 (Lab Remote Valve - Fine Needle)

### EXAMPLE



### LRV-F2-A1F

Fine needle valve with left hand 45° angle base, compression cartridge, metal cross handle with HE index button.

### Base

A



RH 45° Angle



LH 45° Angle



Concealed Valve



Angle Valve for Straight Panels



Angle Valve for 45° Angle Panels

### Cartridge

B



Fine Needle Compression

### Handle

C



Metal Cross

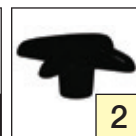

Plastic Cross

### Button

D

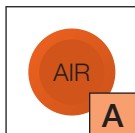

Plastic, "AIR" Index

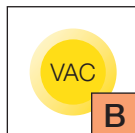

Plastic, "VAC" Index

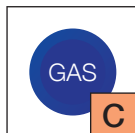

Plastic, "GAS" Index

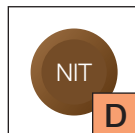

Plastic, "NIT" Index

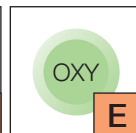

Plastic, "OXY" Index



Plastic, "HE" Index

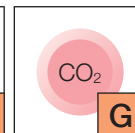

Plastic, "CO2" Index

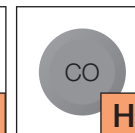

Plastic, "CO" Index

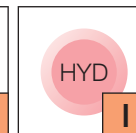

Plastic, "HYD" Index

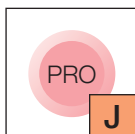

Plastic, "PRO" Index

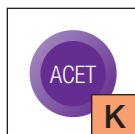

Plastic, "ACET" Index

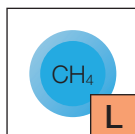

Plastic, "CH4" Index

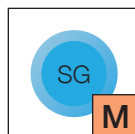

Plastic, "SG" Index

### Water Valve, Right Hand 45° Angle

- Solid brass right hand 45° angle base
- Compression cartridge
- 3/8" NPT female thread inlet and outlet



Button	Metal Cross Handle	Plastic Cross Handle
Cold Water	<b>LRV-W1-A1A</b>	LRV-W1-A2A
Hot Water	LRV-W1-A1B	LRV-W1-A2B

### Water Valve, Left Hand 45° Angle

- Solid brass left hand 45° angle base
- Compression cartridge
- 3/8" NPT female thread inlet and outlet



Button	Metal Cross Handle	Plastic Cross Handle
Cold Water	LRV-W2-A1A	LRV-W2-A2A
Hot Water	<b>LRV-W2-A1B</b>	LRV-W2-A2B

### Water Valve, Concealed with Escutcheon

- Solid brass concealed valve
- Compression cartridge
- 1/2" NPSM coupling nut for 3/8" or 1/2" flexible risers inlet
- 13/16" - 14 UNS to fit 1/2" OD copper or sweat connection outlet



Button	Metal Cross Handle	Plastic Cross Handle
Cold Water	LRV-W3-A1A	<b>LRV-W3-A2A</b>
Hot Water	LRV-W3-A1B	LRV-W3-A2B

### Water Valve, Concealed Valve

- Solid brass concealed valve
- Compression cartridge
- 3/8" NPT female thread inlet and outlet



Button	Metal Cross Handle	Plastic Cross Handle
Cold Water	<b>LRV-W4-A1A</b>	LRV-W4-A2A
Hot Water	LRV-W4-A1B	LRV-W4-A2B

### Angle Water Valve, for Straight Panels

- Solid brass angle valve for straight panels
- Compression cartridge
- 3/8" NPT female thread inlet and outlet



Button	Metal Cross Handle	Plastic Cross Handle
Cold Water	LRV-W5-A1A	LRV-W5-A2A
Hot Water	LRV-W5-A1B	<b>LRV-W5-A2B</b>

### Angle Water Valve, for 45° Angle Panels

- Solid brass angle valve for 45° angle panels
- Compression cartridge
- 3/8" NPT female thread inlet and outlet



Button	Metal Cross Handle	Plastic Cross Handle
Cold Water	LRV-W6-A1A	LRV-W6-A2A
Hot Water	<b>LRV-W6-A1B</b>	LRV-W6-A2B

### Steam Valve, Right Hand 45° Angle

- Solid brass right hand 45° angle base
- Slow compression steam cartridge
- 3/8" NPT female thread inlet and outlet



Model
LRV-S1-A1A

### Steam Valve, Left Hand 45° Angle

- Solid brass left hand 45° angle base
- Slow compression steam cartridge
- 3/8" NPT female thread inlet and outlet
- Plastic cross handle
- Steam index button



Model
LRV-S2-A1A

### Steam Valve, Concealed Valve

- Solid brass concealed valve
- Slow compression steam cartridge
- 3/8" NPT female thread inlet and outlet
- Plastic cross handle
- Steam index button



Model
LRV-S4-A1A

### Angle Steam Valve, for Straight Panels

- Solid brass angle valve for straight panels
- Slow compression steam cartridge
- 3/8" NPT female thread inlet and outlet
- Plastic cross handle
- Steam index button



Model
LRV-S5-A1A

### Angle Steam Valve, for 45° Angle Panels

- Solid brass angle valve for 45° angle panels
- Slow compression steam cartridge
- 3/8" NPT female thread inlet and outlet
- Plastic cross handle
- Steam index button



Model
LRV-S6-A1A

### Needle Valve, Right Hand 45° Angle

- Solid brass right hand 45° angle base
- Compression cartridge
- 3/8" NPT female thread inlet and outlet



Button	Metal Cross Handle	Plastic Cross Handle
AIR	<b>LRV-N1-A1A</b>	LRV-N1-A2A
VAC	LRV-N1-A1B	LRV-N1-A2B
GAS	LRV-N1-A1C	LRV-N1-A2C
NIT	LRV-N1-A1D	LRV-N1-A2D
OXY	LRV-N1-A1E	LRV-N1-A2E
HE	LRV-N1-A1F	LRV-N1-A2F
CO2	LRV-N1-A1G	LRV-N1-A2G
CO	LRV-N1-A1H	LRV-N1-A2H
HYD	LRV-N1-A1I	LRV-N1-A2I
PRO	LRV-N1-A1J	LRV-N1-A2J
ACET	LRV-N1-A1K	LRV-N1-A2K
CH4	LRV-N1-A1L	LRV-N1-A2L
SG	LRV-N1-A1M	LRV-N1-A2M

### Needle Valve, Left Hand 45° Angle

- Solid brass left hand 45° angle base
- Compression cartridge
- 3/8" NPT female thread inlet and outlet



Button	Metal Cross Handle	Plastic Cross Handle
AIR	LRV-N2-A1A	LRV-N2-A2A
VAC	LRV-N2-A1B	LRV-N2-A2B
GAS	LRV-N2-A1C	LRV-N2-A2C
NIT	LRV-N2-A1D	LRV-N2-A2D
OXY	LRV-N2-A1E	<b>LRV-N2-A2E</b>
HE	LRV-N2-A1F	LRV-N2-A2F
CO2	LRV-N2-A1G	LRV-N2-A2G
CO	LRV-N2-A1H	LRV-N2-A2H
HYD	LRV-N2-A1I	LRV-N2-A2I
PRO	LRV-N2-A1J	LRV-N2-A2J
ACET	LRV-N2-A1K	LRV-N2-A2K
CH4	LRV-N2-A1L	LRV-N2-A2L
SG	LRV-N2-A1M	LRV-N2-A2M

### Needle Valve, Concealed Valve

- Solid brass concealed valve
- Compression cartridge
- 3/8" NPT female thread inlet and outlet



Button	Metal Cross Handle	Plastic Cross Handle
AIR	LRV-N4-A1A	LRV-N4-A2A
VAC	LRV-N4-A1B	LRV-N4-A2B
GAS	LRV-N4-A1C	LRV-N4-A2C
NIT	LRV-N4-A1D	LRV-N4-A2D
OXY	LRV-N4-A1E	LRV-N4-A2E
HE	LRV-N4-A1F	LRV-N4-A2F
CO2	LRV-N4-A1G	LRV-N4-A2G
CO	LRV-N4-A1H	LRV-N4-A2H
HYD	LRV-N4-A1I	LRV-N4-A2I
PRO	<b>LRV-N4-A1J</b>	LRV-N4-A2J
ACET	LRV-N4-A1K	LRV-N4-A2K
CH4	LRV-N4-A1L	LRV-N4-A2L
SG	LRV-N4-A1M	LRV-N4-A2M



## Angle Needle Valve, for Straight Panels

- Solid brass angle valve for straight panels
- Compression cartridge
- 3/8" NPT female thread inlet and outlet



Button	Metal Cross Handle	Plastic Cross Handle
AIR	LRV-N5-A1A	LRV-N5-A2A
VAC	LRV-N5-A1B	LRV-N5-A2B
GAS	LRV-N5-A1C	LRV-N5-A2C
NIT	LRV-N5-A1D	LRV-N5-A2D
OXY	LRV-N5-A1E	LRV-N5-A2E
HE	LRV-N5-A1F	LRV-N5-A2F
CO2	<b>LRV-N5-A1G</b>	LRV-N5-A2G
CO	LRV-N5-A1H	LRV-N5-A2H
HYD	LRV-N5-A1I	LRV-N5-A2I
PRO	LRV-N5-A1J	LRV-N5-A2J
ACET	LRV-N5-A1K	LRV-N5-A2K
CH4	LRV-N5-A1L	LRV-N5-A2L
SG	LRV-N5-A1M	LRV-N5-A2M

## Angle Needle Valve, for 45° Angle Panels

- Solid brass angle valve for 45° angle panels
- Compression cartridge
- 3/8" NPT female thread inlet and outlet



Button	Metal Cross Handle	Plastic Cross Handle
AIR	LRV-N6-A1A	LRV-N6-A2A
VAC	LRV-N6-A1B	LRV-N6-A2B
GAS	LRV-N6-A1C	LRV-N6-A2C
NIT	LRV-N6-A1D	LRV-N6-A2D
OXY	LRV-N6-A1E	LRV-N6-A2E
HE	LRV-N6-A1F	LRV-N6-A2F
CO2	LRV-N6-A1G	LRV-N6-A2G
CO	LRV-N6-A1H	<b>LRV-N6-A2H</b>
HYD	LRV-N6-A1I	LRV-N6-A2I
PRO	LRV-N6-A1J	LRV-N6-A2J
ACET	LRV-N6-A1K	LRV-N6-A2K
CH4	LRV-N6-A1L	LRV-N6-A2L
SG	LRV-N6-A1M	LRV-N6-A2M

### Fine Needle Valve, Right Hand 45° Angle

- Solid brass right hand 45° angle base
- Compression cartridge
- 3/8" NPT female thread inlet and outlet



Button	Metal Cross Handle	Plastic Cross Handle
AIR	LRV-F1-A1A	LRV-F1-A2A
VAC	LRV-F1-A1B	LRV-F1-A2B
GAS	<b>LRV-F1-A1C</b>	LRV-F1-A2C
NIT	LRV-F1-A1D	LRV-F1-A2D
OXY	LRV-F1-A1E	LRV-F1-A2E
HE	LRV-F1-A1F	LRV-F1-A2F
CO2	LRV-F1-A1G	LRV-F1-A2G
CO	LRV-F1-A1H	LRV-F1-A2H
HYD	LRV-F1-A1I	LRV-F1-A2I
PRO	LRV-F1-A1J	LRV-F1-A2J
ACET	LRV-F1-A1K	LRV-F1-A2K
CH4	LRV-F1-A1L	LRV-F1-A2L
SG	LRV-F1-A1M	LRV-F1-A2M

### Fine Needle Valve, Left Hand 45° Angle

- Solid brass left hand 45° angle base
- Compression cartridge
- 3/8" NPT female thread inlet and outlet



Button	Metal Cross Handle	Plastic Cross Handle
AIR	LRV-F2-A1A	LRV-F2-A2A
VAC	LRV-F2-A1B	LRV-F2-A2B
GAS	LRV-F2-A1C	LRV-F2-A2C
NIT	LRV-F2-A1D	LRV-F2-A2D
OXY	LRV-F2-A1E	LRV-F2-A2E
HE	LRV-F2-A1F	LRV-F2-A2F
CO2	LRV-F2-A1G	LRV-F2-A2G
CO	LRV-F2-A1H	LRV-F2-A2H
HYD	LRV-F2-A1I	LRV-F2-A2I
PRO	LRV-F2-A1J	LRV-F2-A2J
ACET	LRV-F2-A1K	<b>LRV-F2-A2K</b>
CH4	LRV-F2-A1L	LRV-F2-A2L
SG	LRV-F2-A1M	LRV-F2-A2M

### Fine Needle Valve, Concealed Valve

- Solid brass concealed valve
- Compression cartridge
- 3/8" NPT female thread inlet and outlet



Button	Metal Cross Handle	Plastic Cross Handle
AIR	LRV-F4-A1A	LRV-F4-A2A
VAC	LRV-F4-A1B	LRV-F4-A2B
GAS	LRV-F4-A1C	LRV-F4-A2C
NIT	LRV-F4-A1D	LRV-F4-A2D
OXY	LRV-F4-A1E	LRV-F4-A2E
HE	LRV-F4-A1F	LRV-F4-A2F
CO2	LRV-F4-A1G	LRV-F4-A2G
CO	LRV-F4-A1H	LRV-F4-A2H
HYD	LRV-F4-A1I	LRV-F4-A2I
PRO	LRV-F4-A1J	LRV-F4-A2J
ACET	LRV-F4-A1K	LRV-F4-A2K
CH4	LRV-F4-A1L	LRV-F4-A2L
SG	<b>LRV-F4-A1M</b>	LRV-F4-A2M

## Angle Fine Needle Valve, for Straight Panels

- Solid brass angle valve for straight panels
- Compression cartridge
- 3/8" NPT female thread inlet and outlet



Button	Metal Cross Handle	Plastic Cross Handle
AIR	LRV-F5-A1A	LRV-F5-A2A
VAC	LRV-F5-A1B	LRV-F5-A2B
GAS	LRV-F5-A1C	LRV-F5-A2C
NIT	LRV-F5-A1D	<b>LRV-F5-A2D</b>
OXY	LRV-F5-A1E	LRV-F5-A2E
HE	LRV-F5-A1F	LRV-F5-A2F
CO2	LRV-F5-A1G	LRV-F5-A2G
CO	LRV-F5-A1H	LRV-F5-A2H
HYD	LRV-F5-A1I	LRV-F5-A2I
PRO	LRV-F5-A1J	LRV-F5-A2J
ACET	LRV-F5-A1K	LRV-F5-A2K
CH4	LRV-F5-A1L	LRV-F5-A2L
SG	LRV-F5-A1M	LRV-F5-A2M

## Angle Fine Needle Valve, for 45° Angle Panels

- Solid brass angle valve for 45° angle panels
- Compression cartridge
- 3/8" NPT female thread inlet and outlet



Button	Metal Cross Handle	Plastic Cross Handle
AIR	LRV-F6-A1A	LRV-F6-A2A
VAC	LRV-F6-A1B	LRV-F6-A2B
GAS	LRV-F6-A1C	LRV-F6-A2C
NIT	LRV-F6-A1D	LRV-F6-A2D
OXY	LRV-F6-A1E	LRV-F6-A2E
HE	LRV-F6-A1F	LRV-F6-A2F
CO2	LRV-F6-A1G	LRV-F6-A2G
CO	LRV-F6-A1H	LRV-F6-A2H
HYD	LRV-F6-A1I	LRV-F6-A2I
PRO	LRV-F6-A1J	LRV-F6-A2J
ACET	LRV-F6-A1K	LRV-F6-A2K
CH4	<b>LRV-F6-A1L</b>	LRV-F6-A2L
SG	LRV-F6-A1M	LRV-F6-A2M

## Single Gang Electrical Boxes

- For 120 volt service
- 3/4" NPSM male mounting shank assembly



Single Face	Double Face
1310-BAF	1311-BAF

## Double Gang Electrical Boxes

- For 120 volt service
- 3/4" NPSM male mounting shank assembly



Single Face	Double Face
1312-BAF	1313-BAF

## Rods

- Choice of aluminum upright or crossbar



Dimensions	Upright	Crossbar
3/4" x 24"	9911-NF	9906-NF
3/4" x 36"	9902-NF	9903-NF
3/4" x 39"	-	9905-NF
3/4" x 48"	9912-NF	9907-NF

## Aluminum Burette Rod Sockets

- Choice of 3/4" recessed or countertop mount



Recessed Mount	Countertop Mount
9901-NF	9913-NF

## Aluminum Adjustable Clamp

- Used to secure upright and crossbar rods



3/4" Adjustable Clamp
9904-NF



### Deck Mounted Eye/Face Wash with Push Paddle Handle

- 1/2" NPSM supply inlet
- High impact ABS spray head with cover



Left Hand Operation
8004-LHNF
Right Hand Operation
<b>8004-RHNF</b>

### Deck Mounted Swing Down Eye/Face Wash

- 1/2" NPSM supply inlet
- High impact ABS spray head with cover



Swing Down
8010-NF

### Deck Mount Swing Forward Eye/Face Wash

- 1/2" NPSM supply inlet
- High impact ABS spray head with cover



Swing Forward
8011-NF

### Deck Mounted Single Outlet Eye/Face/Body Drench Hose

- 1/2" NPT male thread inlet
- 8 foot rubber hose
- High impact ABS spray head with cover

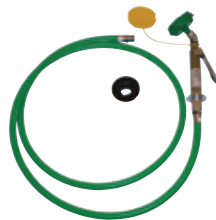

Drench Hose
8305-NF

### Wall Mounted Eye/Face Wash with Push Paddle Handle

- 1/2" NPT female thread inlet
- Choice of stainless steel or plastic receptacle
- High impact ABS spray head with cover
- 1-1/4" NPT female thread waste outlet



Stainless Steel Receptacle
8001-NF
Plastic Receptacle
8008-NF

### Wall Mounted Single Outlet Eye/Face/Body Drench Hose

- 1/2" NPT thread inlet with wall flange
- 12 foot rubber hose
- High impact ABS spray head with cover



Drench Hose
8310-NF

## Floor Mounted Eye/Face Wash with Push Paddle Handle

- 1/2" NPT female thread inlet
- Stainless steel receptacle
- 1-1/4" NPT female thread waste outlet



Eye/Face Wash
8003-NF

## Deck Mounted Combination Eye/Face Wash and Safety Drench Shower

- 1-1/4" NPT female thread inlets
- 1-1/4" NPT female thread waste outlet
- 94" maximum overall height
- Stainless steel pull rod
- Choice of stainless steel or plastic receptacle
- High impact ABS spray head with cover



Stainless Steel Receptacle
8202-NF
Plastic Receptacle
8206-NF
Wheel Chair Accessible Stainless Steel Receptacle
8205-NF

## Drench Showers

- 1" NPT female thread inlet
- Stainless steel pull rod
- Stainless steel or plastic shower flange



Exposed Mount
8100-NF
Concealed Mount
8101-NF

## Barrier Free, Recessed Eye/Face Wash and Safety Drench Shower

- 18 gauge type 304 stainless steel recessed cabinet
- Wheel chair accessible
- Stainless steel shower head



Recessed Mount
8320-NF









We are a member of the U.S. Green Building Council and support the Leadership in Energy and Environmental Design (LEED) Green Building Rating System™, to measure the efficiency and sustainability of buildings in the U.S. and Canada. If you are trying to achieve LEED Certification for your building, our low-flow outlets, metering cartridges, and sensor-operated faucets can contribute points in these areas: Water Efficiency Credit 2: Innovative Wastewater Technologies and Water Efficiency Credit 3: Water Use Reduction



We are proud to be a partner with WaterSense®, sponsored by the EPA and designed to protect the future of our nation's water supply by promoting efficiency and enhancing the market for water efficient products, programs, and practices.



We are a charter sponsor of the Alliance for Water Efficiency, a non-profit organization that is dedicated to the efficient and sustainable use of water. It brings together a diverse range of stakeholders to advocate water efficiency and conservation.



a Geberit company

Chicago Faucets, a member of the Geberit Group, is the leading brand of commercial faucets and fittings in the United States, offering a complete range of products for schools, laboratories, hospitals, office buildings, food service, airports, and sports facilities. Whatever your requirements may be, Chicago Faucets offers standard and made-to-order products that are designed to meet any commercial application.

The Chicago Faucet Company  
2100 South Clearwater Drive  
Des Plaines, IL 60018  
Phone: 847/803-5000  
Fax: 847/803-5454  
Technical: 800/832-8783  
[www.chicagofaucets.com](http://www.chicagofaucets.com)

